



# Signature Inset 5



PLEASE RETAIN THIS GUIDE FOR FUTURE REFERENCE

**BK075**

EN 13240:2001+  
Amd. A2:2004

Rev. 06  
October 2009  
Part No. AFS1397

09 The CE mark is a stylized 'C' and 'E' symbol, indicating compliance with European standards.



---

Congratulations on your choice of an Aarrow Stove.

More than 20 years experience has been put into the development of our **Signature Inset** range to ensure ultimate performance and years of trouble free use and enjoyment.

Every detail of the stove has been carefully designed and engineered which is why we are so confident in the reliability of our products.

Should you have any questions about our **Signature Inset** stoves that are not covered by this manual, please contact The Aarrow retailer in your area, or call our technical support department on 0844 847 5107.

---

All Aarrow **Signature Inset** stoves are approved to European Standard EN 13240 and CE marked.

These appliances listed within this manual have been approved by *HETAS Ltd* as an intermittent operating appliance for burning wood only.

**Copyright 2009**

Arada Ltd

This booklet has copyright and may not be copied in whole, or part, or used for any purpose other than that for which it is supplied without express written consent from Arada Ltd

**PLEASE NOTE—** *Arada has a policy of continuous product development and therefore we reserve the right to amend the specification without prior notice.*

*Due to printing cycles, items or options may be described before they are generally available or after they have ceased, so please check with your retailer or dealer.*

# CONTENTS

---

<b><u>INTRODUCTION</u></b>	<b>Page No.</b>	<b><u>OPERATING INSTRUCTION</u></b>	<b>Page No.</b>
Warning Notice	4	Suitable Fuel	21
Safety Notices	5	Lighting The Stove	21
The Principle Of The Stove	5	Burning Wood	22
Check List	6-7	Reduced Burning	22
Data Plate Information	7	Over Firing & Chimney Fires	23
Technical data	8	Ash Removal	23
		Air Inlet Controls	24
<b><u>INSTALLATION</u></b>		Fuel Retainer	25
General Precautions	9	Multi Purpose Operating Tool	26
Handling	9	Main Fire Door Handle	27
Air For Combustion	9		
Hearth	9-10	<b>OPTIONAL EXTRA / ACCESSORIES</b>	28
Flues & Chimneys	11-12	<b>SPARE PARTS LIST</b>	29-30
Sealing the back of the Signature 5 stove to the decorative fire surround	12	<b>GUARANTEE</b>	31-32
Firebox Liner Panels	13	<b>GENERAL DIMENSIONS</b>	33
Optional Securing Bolts	14	<b>FACTORY CHECK LIST</b>	34
Final Check	14		
Building Control Consent Checklist	15		
<b><u>SERVICE &amp; MAINTENANCE</u></b>			
Annual Maintenance	16		
Cleaning	16		
Chimney Sweeping	16		
Door Glass	16		
Outer Finish	16		
Summer Storage / Non Usage	17		
Adjusting The Door Hinges	17		
Fuel Retainer Inspection	17		
Fire Door Rope Replacement	18-19		
Fire Door Glass Replacement	18-19		
Disassemble The Primary Air Control	19		
Service Record	20		

---

---

# WARNING

IT IS A LEGAL REQUIREMENT THAT THE INSTALLATION OF ALL NEW OR REPLACEMENT, WOOD OR SOLIDFUEL HEATING APPLIANCES ARE REQUIRED TO OBTAIN BUILDING CONTROL APPROVAL FROM YOUR LOCAL AUTHORITY OR THE INSTALLATION WORK MUST BE CARRIED OUT THROUGH A GOVERNMENT APPROVED COMPETENT PERSONS SCHEME SUCH AS OPERATED BY HETAS.

IF IN DOUBT, CONTACT HETAS LIMITED  
TELEPHONE NUMBER : 0845 634 5626  
[www.hetas.co.uk](http://www.hetas.co.uk)

THIS STOVE MUST NOT BE CONNECTED  
TO A SHARED FLUE SYSTEM

**TO ALL USERS**  
PETROLEUM COKE  
SOME OF WHOSE BRAND NAMES ARE  
**'CALCO', 'PETROCOKE' AND 'WONDERCO'**  
MUST NOT BE BURNED IN THIS APPLIANCE

BITUMINOUS HOUSE COAL  
SHOULD NEVER BE USED IN YOUR STOVE

TO USE THESE FUELS WILL INVALIDATE  
THE APPLIANCE GUARANTEE.

**IF IN DOUBT CONTACT THE SOLID FUEL ASSOCIATION**  
**TELEPHONE NUMBER 0845 601 4406**  
[www.solidfuel.co.uk](http://www.solidfuel.co.uk)

## SAFETY

A fireguard conforming to BS 8423:2002 should be used in the presence of children and old or infirm people.

Please note, this appliance should be used with the fire door closed at all times except when re-fuelling, initial lighting or de-ashing.

**Do not use aerosol sprays or any other flammable materials near the appliance under fire.**

**Do not fit an extractor fan in the same room as the appliance.**

**Fire cement is caustic, hand and eye protection should always be worn, prolonged contact with the skin should be avoided.**

**Arada Ltd will not be responsible for any consequential or incidental loss or injury however caused.**

Before continuing any further, with the installation of this appliance please read the following guide to manual handling.

- Always obtain assistance when lifting the appliance
- When lifting always keep your back straight, bend your legs not your back
- Avoid twisting at the waist. It is better to reposition your feet.
- Avoid upper body/top heavy bending. Do not lean forwards or sideways when handling the fire
- Always grip with the palms of your hands do not use your fingertips for support
- Always keep the stove as close to the body as possible as this will minimise the

cantilever action.

## THE PRINCIPLE OF THE STOVE

Your **Arrow** stove is built to the highest standard of craftsmanship using the best materials and the most modern equipment available. It is a highly efficient and sophisticated piece of machinery and when properly installed and operated it should provide a lifetime of heating satisfaction.

Safety is the most important consideration when installing your fire. If not properly installed and operated a house fire may result. Installation must comply with the Building Regulations and conform to all safety standards.

**Arrow** produce a variety of appliances ranging from the traditional to the modern in style and appearance, all bristling with 'High Tech' features.

The fire door is fitted with a special high temperature ceramic glass panel through which the fire can be viewed.

The stove is lined with firebricks or heat reflective panels which ensure complete combustion and provide a good heat store to even out fluctuations in burning.







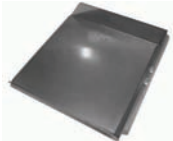


An internal throat plate produces turbulence to encourage secondary combustion and direct the flue gas around the whole upper firebox before allowing it to escape up the chimney.

**Arrow** stoves are also fitted with an 'air wash' so called because it provides a curtain of high speed preheated air behind the glass to help keep it clean and provide secondary air/over draught.

Optimum setting will only be established by experience in firing the appliance, and will depend on the type of fuel, the position of the appliance in the house, and conditions of chimney etc.




# CHECK LIST

Inside the appliance body you should find the following:

Part Description & Visual Aid	(not to scale)	Signature Inset 5
1. Fuel Retainer		1
2. Throat Plate		1
3. Side Liner		2
4. Back Liner		1
5. Wood Burning Tray		1
6. Tertiary Air Bar		1
7. Ash Pan		1
8. Operating Tool		1
9. Instruction Manual		1

# CHECK LIST

Inside the appliance body you should find the following, Cont:

Part Description & Visual Aid	(not to scale)	Signature Inset 5
10. Fire Door Handle		1
11. Heat resistance Mitten		1
12. Optional Fixing Bolts		2

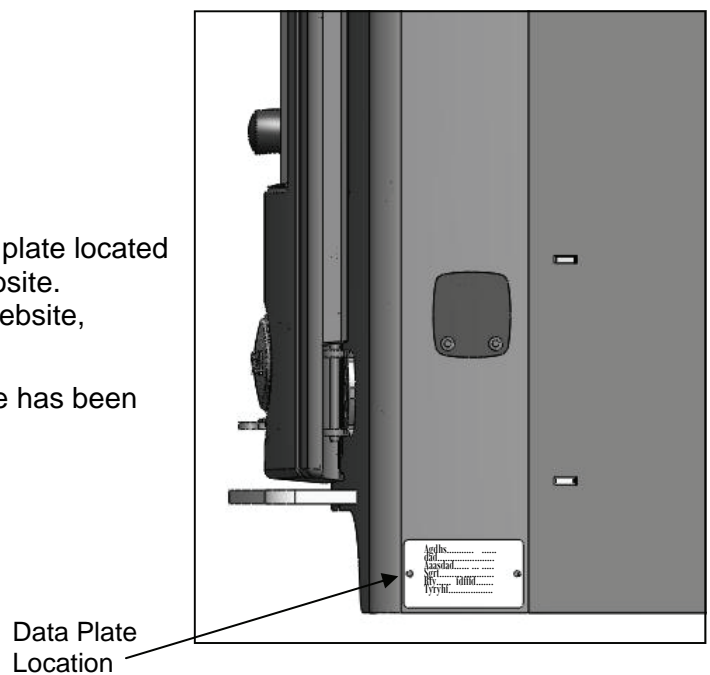
## DATA PLATE INFORMATION

### Data Plate Information

Please Note :

The Arrow Signature 5 stove is fitted with a data plate located on the bottom of the right hand leg as shown opposite. The data given is that registered on the HETAS website, stating the output and performance of the stove.

The **CE** mark indicates that the stove performance has been independently certified by a competent body.



## TECHNICAL DATA

---

<b>Technical Data</b>	<b>Signature Inset 5</b>
<b>Nominal Heat Output (kW)</b>	<b>4.8</b>
<b>Efficiency Nett (%)</b>	<b>80.1</b>
<b>Mean Flue Gas Temperature (°c)</b>	<b>261</b>
<b>Mean CO Emissions @ 13% O<sub>2</sub> (%)</b>	<b>0.50</b>
<b>Height (mm)</b>	<b>590</b>
<b>Width (mm)</b>	<b>562</b>
<b>Depth Overall (mm) (Inc. handle)</b>	<b>435</b>
<b>Depth From Fire surround (mm) (Inc. handle)</b>	<b>210</b>
<b>Distance to combustible material surrounding the appliance (mm)</b>	<b>200</b>
<b>Height to shelf above the appliance</b>	<b>300</b>
<b>Weight Nett (kg)</b>	<b>65</b>
<b>Weight Packed (kg)</b>	<b>68</b>
<b>Standard Chair-brick Size Fitting</b>	<b>16" &amp; 18"</b>



## GENERAL PRECAUTIONS

*Note : All local regulations, including those referring to National and European standards need to be complied with, when installing the appliance.*

The Building Regulations for England and Wales 2000 ref Approved Document J 2002 edition (issued by the DTLR).

The Building Standards (Scotland) (Consolidation) Regulations.

Detailed recommendations for installation of appliances, chimneys and flues are outlined in the current issue of the following British Standards : BS6461, BS8303 & BS4543.

***Any Manufacturer's Instructions must not be taken as overriding statutory requirements.***

***Before any installation work is undertaken consideration must be given to the Health and Safety at Work Act 1974. Safe working practices should be followed at all times.***

During installation ensure that adequate precautions are taken to avoid unnecessary risk to yourself or any householder. In particular the danger from the caustic nature of the fire cement should be avoided by using these accepted methods :

- Wear gloves when handling fire cement
- Wear goggles when chiselling or looking up chimneys.

Make sure that Building Regulations are adhered to during installation along with any local by-laws. In the case of heating systems make sure that the pipe work is correctly bonded to ensure electrical earth continuity.

## ASBESTOS

All Aarrow stoves contain no asbestos in their manufacture or construction. If there is a possibility of disturbing any asbestos in the course of the installation, then please seek specialist guidance and use appropriate protective equipment.

## HANDLING

By the time you read this, you will appreciate the weight of the appliance. The safety & handling guidelines as set out on page 5 of this manual should be followed.

To make movement easier internal fittings, fuel retainers, grates, firebox liners, flue outlets, hot plates, throat plates etc, can be removed.

Care should be taken to make sure that the hinges are not damaged during installation.

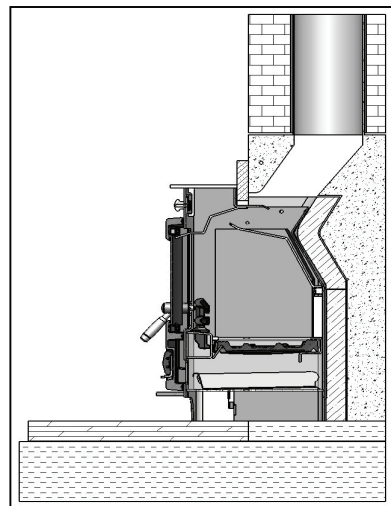
## HEARTH / FIRE SURROUND

The stove must be installed on a floor with adequate load bearing capacity. If the existing construction does not meet this prerequisite, suitable measures (e.g.: load distributing plate) should be taken to achieve it.

Ideally, the appliance should stand on a constructional hearth of non-combustible materials not less than 125mm (5") thick conforming to Building Regulations.

Dimensions of the hearth should project at least 228mm (9") forward of the front of the appliance and 150mm (6") at the sides.

The surface of the hearth should be free of combustible materials. In most buildings with solid concrete or stone floors, the requirement will be met by the floor itself, but mark the hearth to ensure floor coverings are kept well away or use different levels to mark the hearth perimeter.



See page 10 for detailed image

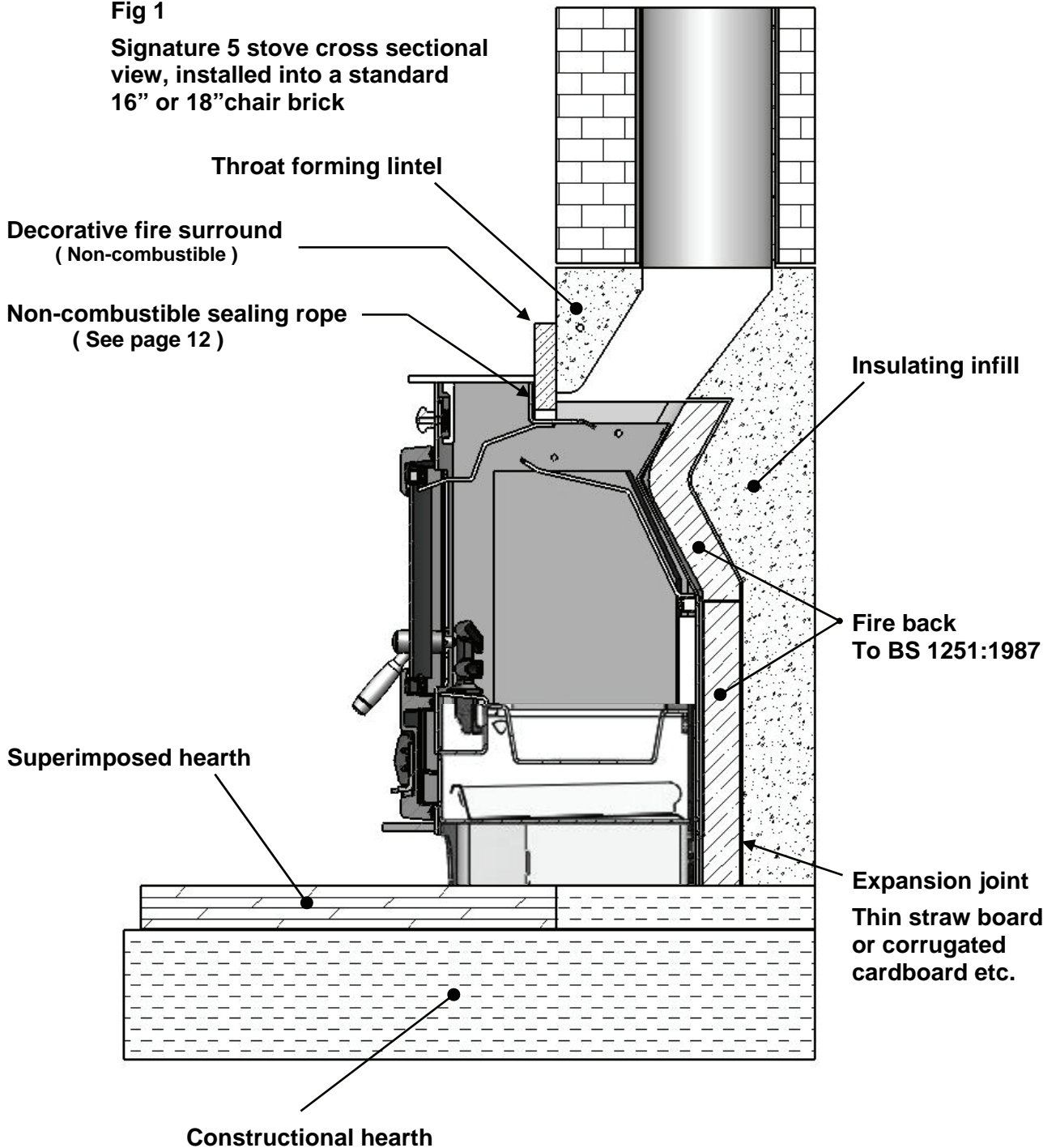
## AIR FOR COMBUSTION

There must always be a permanent means of providing air for combustion into the room in which the stove is installed. A permanent vent with a total free area of at least 550mm<sup>2</sup> for every KW rated above 5KW should be connected directly to the outside air or to an adjacent room which itself has a permanent vent of the same size direct to the outside air. The positioning of any air vent must be such that it cannot be liable to blockage or obstruction. **Please note:** The fitting of an extractor fan to either of these rooms is not permitted.

# INSTALLATION

The stove should fit into a standard 16" or 18" open fire place without the removal of the fire-back (chair brick), provided the same complies to BS 1251:1987. Some minor adjustment may be required to ensure a good fit. The decorative fire surround should be manufactured from non-combustible materials only.

**Fig 1**  
**Signature 5 stove cross sectional view, installed into a standard 16" or 18" chair brick**



### FLUES AND CHIMNEYS

The flue draw is critical on any installation and should be checked to ensure that it matches what is specified. If it is higher than recommended, provision must be made to correct the over draw. The draw can vary in different weather conditions and the customer should be made aware of this. Failure to correct an over-drawing flue will invalidate the warranty.

Please remember that chimney draught is dependent on four main factors :

- Flue gas temperature
- Flue height
- Flue size
- Flue terminal

The stove must be connected to a suitable and efficient flue that takes products of combustion (fumes) from the stove outlet to the outside air. To ensure a good up draught it is important that the flue gases are kept warm and that the flue size suits the stove. The termination of the outlet at the top of the flue also needs to comply with Building Regulations. The minimum effective height of the flue must be at least 4.5 metres from the top of the stove to the top of the flue outlet. When warm the flue draught should be between 0.1 to 0.2 mb. A chimney may comply with regulations but still be subject to down draught and similar problems. A chimney terminating above the ridge level is generally less likely to suffer such problems.

If a new chimney is being provided it should fully comply with the relevant Building Regulations that specify the requirements for solid fuel burning installations. Suitable types of chimney include the following :

**Masonry Chimney** : Built with clay or concrete liners, or a chimney block system meeting Building Regulations. These types of chimney should be installed in accordance with the Building Regulations and BS 6461:Part 1.

**Factory Made Insulated Chimney** : Complying with BS 4543:Part 2 (often called "Class 1 prefabricated metal chimney"). These types of chimney should be installed in accordance with Building Regulations and BS 7566: Parts 1 to 4.

Due to the gradual introduction of Europe Chimney Standards, chimneys will be specified according to their performance designation as defined in BS EN 1443 that covers the General Requirements for chimneys. The minimum performance designation required for use with solid fuel burning stoves is T450 N2 S D3.

The flue and chimney installation must be carefully checked by a competent person before fitting the stove to ensure it is suitable and will work safely.

If the chimney is old (ie: built of brick or stone without a liner) or being opened up for reuse additional checks and smoke testing as described in Appendix E of the Approved Document J 2002 Edition should also be carried out to ensure the flue and chimney are in good operating condition.

Unless the existing flue is in good condition with suitable access for collection and removal of debris. If the flue size is more than 225mm (9") diameter or 200mm (8") x 200mm (8") square, a suitable lining of 150mm (6") diameter should be fitted, or if the flue length is over 5.5 metres one size larger than the appliance outlet should be fitted. This should be a double skin stainless steel flexible liner that is independently certified for use with solid fuel. Details of suitable linings for use with wood & solid fuel are given in the Official HETAS guide that can be viewed on their website at [www.hetas.co.uk](http://www.hetas.co.uk).

It is also important that suitable flue pipe complying with the Building Regulations is used to connect the stove to the flue in the chimney and that suitable access is provided into the flue for regular inspection and sweeping of the flue ways.

The installer should comply with Building Regulations requirements in respect of providing a Notice Plate giving details on the chimney, flue lining, hearth and fireplace installation. Approved Document J of the Building Regulations for England & Wales is available from The Stationery Bookshops and can also be viewed at the ODPM website at [www.safety.odpm.gov.uk/bregs/brads.htm](http://www.safety.odpm.gov.uk/bregs/brads.htm).

Details on the relevant Building Regulations and BS British Standards are given in the "General Precautions" section of these instructions.

Chimneys should be as straight as possible. Horizontal runs should be avoided.

## INSTALLATION

### IMPORTANT NOTICE:

During installation it is advisable to remove the **Stove Door**. The stove may become **front heavy** should the door be opened during positioning, prior to the stove being secured in place with the provided masonry bolts, ( See page 14 ). If the stove is left unsupported and the door is fully open it may tip forward causing damage to the stove door or stove body or to the surrounding hearth / brickwork etc.

### FOR ALL APPLIANCES

Access for cleaning the flue should be incorporated in the system other than through the appliance (eg: a soot door or access through register plate). Purpose made soot doors and inspection lengths are available from manufacturers of all systems. Ensure that the whole length of the flue can be reached from the soot door.

**Note: If the appliance is fitted with a draught stabiliser or if one is fitted to the flue pipe or chimney in the same room as the appliance, then the permanent air entry opening (or Openings) should be increased by 300mm<sup>2</sup> for each KW of rated output.**

For advice on flues and chimneys contact:

**NACE (National Association of Chimney Engineers)**

Telephone : 0800 0924019

[www.nace.org.uk](http://www.nace.org.uk)

OR

**NACS (National Association of Chimney Sweeps)**

Telephone : 01785 811732

[www.chimneyworks.co.uk](http://www.chimneyworks.co.uk)

OR

**HETAS (Official Body To Approve Solidfuel Domestic Heating Appliances)**

Telephone : 0845 6345626

[www.hetas.co.uk](http://www.hetas.co.uk)

### Sealing the back of the stove to the decorative fire surround

In order for the stove to operate at maximum efficiency it is necessary to achieve a good seal between the back face of the stove convector section, and the decorative hearth surround (See Fig 1 on page 10)

The Signature 5 inset stove is supplied with a pre-cut length of 7mm dia. heat resistant rope (1.85metres) with a self adhesive edge to achieve this.

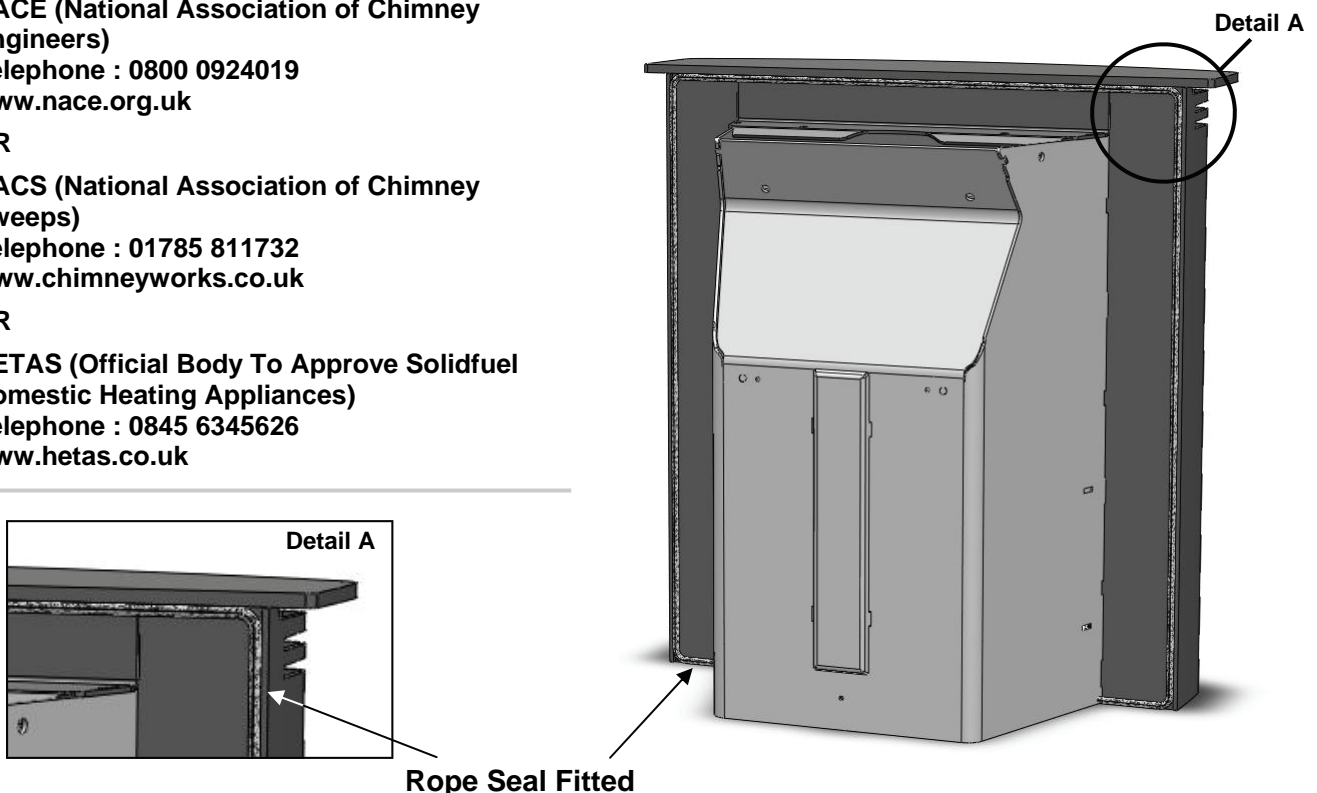
Alternative methods may also be employed to seal the stove if more appropriate in a particular installation. IE fire cement, high temp silicon sealant etc..

To apply the rope seal, peel back a short section of the adhesive protection paper (about 150mm) at a time and apply the rope to the back face of the stove convector section as shown below. Apply the rope tight into the angle created where the side overhangs the back section by approximately 3mm.

Fit the rope all the way round and carefully bend it round the left and right, top & bottom corners without stretching the rope.

The rope will easily form a right angle to do this without cutting.

The rope will compress forming a good seal when the stove is pulled back into the chair brick by the mounting bolts.





## FIREBOX LINER PANELS

The Arrow Signature Inset 5 stoves use firebox liner panels to the sides and back. See fig 2  
 The throat plate sits on top of the sides and rear panels. These should come fitted to your stove, if however they are not, proceed as follows to fit them.

- Open the fire door.
- Remove the cast fuel retaining bar, by lifting free from the front brace.
- Set the small liner into the back of the firebox.
- Insert the side liner panels. (See Fig. 3)
- Fit the throat plate with the single bend to the front facing up. The projecting lugs sit on top of the side liners. The long centre tab on the back edge rests on the tertiary air bar above the rear liner. (See

Fig.4 & 5)

- Replace the front fuel retaining bars.

**Note: Neither the rear firebox liner nor the side firebox liners are 'handed', both faces are suitable for direct contact with the fire bed.**

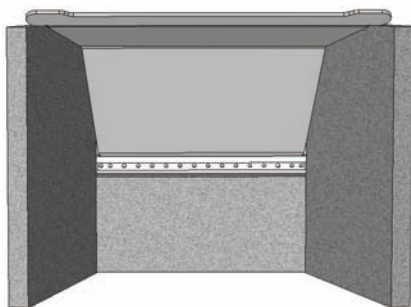
**Note : Cracking of the liner panels does not effect efficiency.**



**Fig. 3. Liners Inserted**

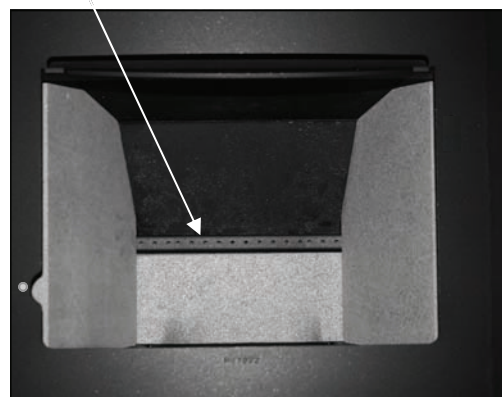


**Fig. 4. Inserting The Throat Plate**



**Fig. 2. Overall View Of Liners & Throat Plate Assembly**

Tertiary air bar



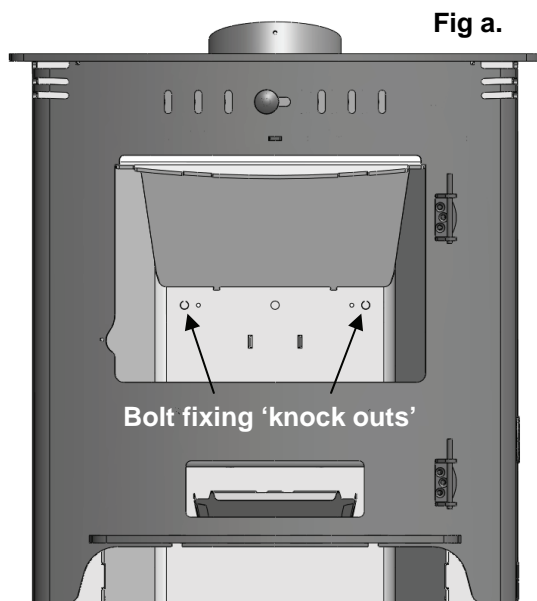
**Fig. 5. Liners & Throat Plate Correctly Fitted**

# INSTALLATION

## MASONRY FIXING BOLTS

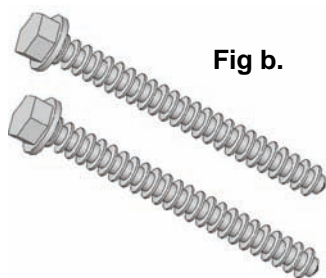
The Signature Inset 5 is supplied with masonry fixing bolts to allow the installer to bolt the stove in place, to the back of the chair brick if required.

In order to do this it will be necessary to remove the 'knock out' hole plugs in the rear of the stove. These are located behind the tertiary air bar, which must be removed to access these fastening holes. See Fig a, below.



The fixing bolts supplied with the stove are designed to be screwed directly into masonry without the need for any form of wall plugs. A pilot hole of 6mm will need to be pre-drilled. Take care not to over tighten the fixing bolts as this may damage the chair brick / wall, or strip out the formed thread requiring involved repair work.

Fixing bolts supplied are M10 x 75mm, See Fig b, If longer bolts are found to be required these will have to be supplied by the installer.



## FINAL CHECK LIST

Before handing over the installation to the customer it is requirement under Document J that the appliance is lit and the functioning of the chimney system is checked for satisfactory operation.

- **Be sure that the chimney is operating and ALL smoke and fumes are vented to the atmosphere through the chimney terminal.**
- **Check all joints and seals.**
- **Clean the outside of the appliance to prevent any stains becoming burnt on.**
- **Check the flue draught which should read 1 - 2mm, or 0.1 - 0.2 mbar.**
- **If Building Control Consent route is being sought please complete the check list on page 15.**
- **For a registered Competent Persons Scheme, such as HETAS, please complete the Certificate Of Compliance, which is used for checking and reporting the installation as imposed by the Government**
- **Explain the controls and operation of the appliance to the customer.**

The details on the **Building Control Consent Checklist** ( Page15 ) **must** be checked and completed in full by the installer at the time of installation.

Please answer all questions as fully as possible. **Arrow stoves** cannot be held responsible for the chimney or installation.



## SERVICE & MAINTENANCE

---

### ANNUAL MAINTENANCE

*It is important that your appliance is regularly serviced in accordance with these instructions. This should be carried out at least annually by a qualified person and should consist of the following :*

### CLEANING

**Important;** Under some circumstances soot can quickly build up on the throat plate and adjacent areas. The throat plate should be removed and checked monthly, and any debris stripped off. Similarly, clean the upper surface of the firebox.

Remove the firebrick linings and throat plate, inspect all rope gasket on doors, glass etc, and re-order any items that may need replacing from your **Arrow** dealer.

With a wire brush clean inside the appliance paying particular attention to the small inlet holes of the air wash on the inside, above the fire door.

Sweep the chimney and confirm that it is sound. Examine all joints in the flue pipe etc, and re-seal if necessary. Re-assemble and leave with the air inlet and air wash control about half way open. This will allow a free flow of air through the appliance thus preventing moisture and condensation from building up inside the stove and chimney.

### CHIMNEY SWEEPING

Sweeping should be carried out with an appropriate sized bristle brush and rods to suit chimney size and type. As with all appliances regular sweeping of the flue is essential to avoid danger of blockage and the escape of poisonous fumes. Access for cleaning should also be incorporated in the chimney. (e.g.. Soot door )

Any existing chimney should be swept prior to installation of the appliance, and swept again a second time **within one month** of regular use after installation to establish frequency of sweeping required. This should be done by a competent person such as a NACS chimney engineer who will provide a Certificate Of Chimney Sweeping. The whole flue way including the outlet must be swept at least twice per burning season. It is important that the flue ways, flue pipe and chimney

be cleaned prior to lighting the fire after a prolonged shut down period.

### DOOR GLASS

The door glass should remain clear during normal burning. However, under certain conditions, such as burning at a low rate or damp wood, or overnight burning, the glass may become somewhat blackened. To remedy this, operate the appliance at a fast rate. Alternatively when the stove is cold, open the door and clean the inside face of the glass with a damp cloth or with glass cleaner (available from fire stockists). A piece of cloth moistened with vinegar and dipped in wood ash (**not coal ash**) will provide a good soft scourer to remove the soot without scratching the glass.

### OUTER FINISH

The outer finish of the appliance is a durable high temperature paint. It is best cleaned by brushing down with a clean shoe brush. Do not allow moisture to remain on the appliance whilst cold or surface rust may form.

The high temperature paint should not require attention for some time, depending on use. The hotter the fire burns the sooner repainting will be necessary. Aerosol tins of paint are available for complete refurbishing.

Before repainting make sure that the fire is out and the stove is cold.

- Remove the door glass
- Lightly wire brush, or rub with wire wool, the body of the appliance to remove any loose paint or rust.
- Mask or remove items such as brass work.
- Any adjacent brickwork, mantelpiece, hearth etc, should be carefully masked for quite a distance around the appliance. This precaution is to prevent discolouration of the surrounding brickwork or wall paper etc.

**Re-spray in a well ventilated area, avoid breathing the vapour. Refer to safety instructions on paint cans.**

- When the paint is dry refit the door glass & any other parts previously removed.
- Leave the appliance for eight hours before lighting a fire.
- Burn slowly for the first four hours, then build up heat slowly to gradually cure paint.

*Note: Use genuine Arrow touch up spray as some paints interact. This could ruin the finish and invalidate the guarantee.*



### SUMMER STORAGE / NON USAGE

Please ensure that your stove is left clean and moving components are well lubricated for the summer months (during periods of prolonged non use). If possible store the throat plate outside of the stove, check all moveable components, at regular intervals, to ensure they are moving freely.

Allow air movement through the stove, by opening the air wash and primary air inlet controls to about half way open or leave the door ajar. This will allow a free flow of air through the appliance thus preventing moisture and condensation forming inside the stove and chimney. This preventative maintenance will ensure your stove stays in the best condition for the coming winter months.

### ADJUSTING THE DOOR HINGES

Once the appliance has been under fire for a period of time the fire door may appear to have moved out of alignment in relation to the door aperture or catch. This is quite normal and due to the settling of the casting.

The fire door can be re-aligned as follows :

- When the appliance is cold, open the fire door so that it is at right angles to the front of the stove.
- Lift the fire door up off its hinges.
- Gently tap the hinge pins in the direction to compensate for the misalignment. (Fig. 6)
- Re-fit the door and check to ensure it now sits square to the body; if not repeat the above steps.

If the fire door needs to be raised, please follow :

- When the appliance is cold, open the fire door so that it is at right angles to the front of the stove.
- Lift the fire door up off the hinges.
- Drop one washer 6.35mm ID x 14mm OD on the top and bottom hinge pins.

- Refit the door and check.

**Please Note :** *There is no adjustment to the door lock / catch assembly. However, periodically check the tightness of the retaining screw to the end of the door handle shaft. ( Fig. 7 )*



Fig. 6. Adjusting The Door Hinges

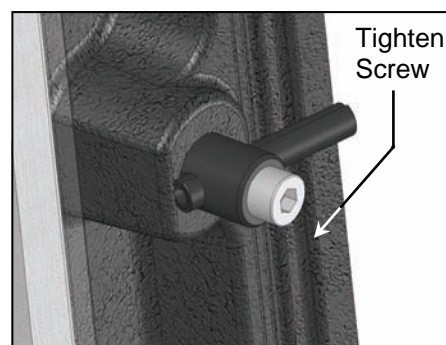


Fig. 7. Retaining Screw Tightness

### FUEL RETAINER INSPECTION

A fuel retainer is supplied with the stove. Periodically check for any bowing to the fuel retainer and replace as necessary.

**Please Note :**  
*This operation should only be carried out when the appliance is unlit and cold.*

## SERVICE & MAINTENANCE

### FIRE DOOR ROPE REPLACEMENT

Periodically, visually check over the fire door rope seal for any damage, cuts or tears and any detached sections. The rope gasket can be replaced, using the universal rope kit (see spare parts guide Page 28/29), please follow the instructions below :

- Ensure the appliance is cold.
- Lift the door off the appliance and lay onto a flat surface with the rear face upwards.
- Carefully remove the old rope gasket and old adhesive. Take note of the layout of the old rope seal. Ensure no traces of the old adhesive or rust / flaky paint is present, as this will result in a unsound joint.
- Apply the rope adhesive following the instructions on the bottle.
- Press the rope gasket into the channel on the rear of the door casting, following the same layout as the old rope seal. See Fig.8
- Just before the final end, cut the rope seal to length and glue into position.
- Allow 30 minutes, before refitting the door to the appliance.



Fig. 8. Rope Replacement

### FIRE DOOR GLASS REPLACEMENT

In the event of the door glass being broken it can easily be replaced. Please follow :

- The door should be lifted off the hinges so that this operation can be carried out on a work bench or similar level surface.
- Unscrew the four screw fixings securing the glass clips and remove both clips and fixings.
- Carefully remove any pieces of broken glass, and sealing gasket, (wearing suitable gloves as protection). Take note of the position and joint of the rope gasket.
- Replace the glass rope gasket; start at the bottom of the window, centrally, push the adhesive side of the rope into the groove on the rear of the casting. Gradually work your way around until the end of the rope meets. See Fig. 9.
- Re-seat the new glass, ensuring the glass sits flat against the gasket. See Fig. 10.
- Replace the four retaining clips and fixing screws. Do not over tighten the fixings as damage may occur to the glass. See Fig.11.
- Refit the door assembly back onto the stove; carefully lift the door over the hinge and slot into place.

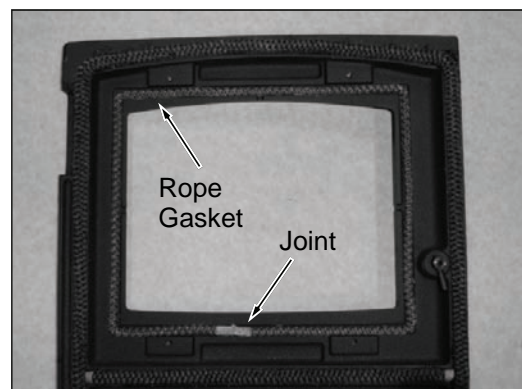


Fig. 9. Lining Up Gasket Rope



**Fig. 10. Positioning The Glass**



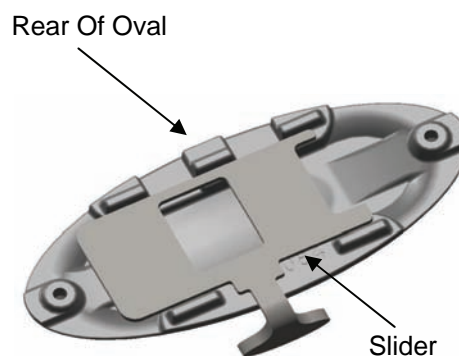
**Fig. 11. Tightening The Glass Clip**

***Please Note—This should be carried out when the fire is cold and unlit.***

### FIRE DOOR PRIMARY AIR INLET

Once a year a check is required to inspect the primary air inlet assembly, located at the base of the fire door.

- Lift the door assembly from the stove body and place on a level work bench, with the rear face upper most.
- Remove the 2 x no. fixings.
- Working from the front, withdraw the oval assembly from the door casting.
- Clean the air slots within the door casting and slider plate.
- Place the oval assembly into the door oval aperture and fix from the rear of the door. See Fig 12



**Fig. 12. Rear Of Oval / Slider Assembly**

## SERVICE & MAINTENANCE

---

### Service Record

Date of Visit	Company Details	Work Carried Out	Signature

Should you have any questions about your Arrow Signature Inset stove that are not covered in this manual please contact your Arrow dealer.

Please keep all repair receipts safely.

Please ensure you have this manual available when an engineer visits so they can complete the service record chart.

# OPERATING INSTRUCTIONS

## SUITABLE FUEL

### SAFETY NOTICE

The most efficient use of this appliance is with the fire door closed at all times, apart from re-fuelling (when alight) or cleaning (when cold).

**NEVER** leave the appliance unattended for an extended length of time with the door open. If this is the case, a spark guard must be used and the operating efficiency of the appliance will decrease.

**WOOD**— Any type of wood is suitable provided it is well seasoned and has a moisture content below 20%. This usually implies that the timber has been suitably stored to allow moisture to evaporate for at least nine months in the case of soft woods, and at least eighteen months in the case of hard wood. We recommend that for general burning, wood should be split into logs of no more than 100mm (4") diameter.

**WARNING** : wet wood must not be used as this will greatly contribute to the creation of tar and creosote which may, in extreme cases, run down the chimney in liquid form. This will seriously damage both the chimney and the appliance, and increase the risk of a chimney fire.

**Please Note** : If you have sticky tar inside the appliance or chimney your wood is 'Green' or too wet.

**Please Note** : The burn classification for all appliances in these instructions are classed as intermittent use.

### Recommended Reading ;

"Wood as a fuel" available from the Forestry Commission.

**PAPER**— Paper will burn successfully. Burn dry paper only or chimney damage will occur.

**WARNING** : NEVER BURN PLASTICS OR HOUSEHOLD WASTE IN YOUR STOVE.

**WARNING** : NEVER BURN LIQUID FUELS IN YOUR STOVE.

**PLEASE CONTACT** : The Manufacturer For Further Details & Advice On The Use Of Other Fuels.

For additional further advice on fuels, please refer to HETAS, Tel 0845 634 5625 or [www.hetas.co.uk](http://www.hetas.co.uk) and or Solid Fuel Association, Tel 0845 601 4406 or [www.solid-fuel.co.uk](http://www.solid-fuel.co.uk)

HETAS Approval only covers the use of wood on the appliance and does not cover the use of other fuels either alone or mixed with other fuels, nor does it cover instructions for uses of other fuels.

### Please Note :

**Do not use petroleum based solid products such as Calco or Petrocoke.**

**To do so will INVALIDATE the appliance Guarantee. (See page 29&30)**

## LIGHTING THE STOVE

**Prior to lighting the stove for the first time, check with the installer that :**

- Installation and all building work is complete.
- The chimney is sound and has been swept and is free from obstruction.
- Adequate provision for combustion air has been made, i.e. a permanent vent of at least 550mm sq per KW of rated output above 5kW, is fitted in the room in which the appliance is installed.
- That Building Regulations and any local by laws have been followed during installation. See installation section of this manual.
- All firebox liner panels and throat plate are in place.
- That the chimney draw has been checked and is within specification. With the chimney warm, the draught should be between 1-2 mm water gauge or 0.1 to 0.2 mbar.

**WARNING** : An over drawing chimney can cause over firing, resulting in damage to the appliance.

**ENSURE THAT YOU HAVE READ & UNDERSTOOD THESE INSTRUCTIONS BEFORE LIGHTING THE FIRE.**

**ALWAYS WEAR SUITABLE PROTECTIVE FIRE GLOVES WHEN REFUELLING YOUR STOVE.**



# OPERATING INSTRUCTIONS

---

## BURNING WOOD

- Set the fire by using rolled up newspaper and a layer of dry kindling wood on top of this.
- Use 2 or 3 fire lighters to light the kindling.
- Set the air wash control to the fully open position. See page 24.
- After the kindling has caught light, leave the fire door ajar by about 20mm. This will aid flue draw.
- The flue draw should be established after 5 minutes and the kindling will burn down to form an ember bed.
- Carefully load the stove with dry, well seasoned wood and close the fire door.
- After 10 to 15 minutes, regulate the air wash control, typically reduce to approximately half way.

**Please Note :**

*The high temperature paint acquires durability by being "cured" during the initial firings of the appliance. It will give off fumes which are non toxic, but certain persons may find they have an unpleasant or irritant effect. Ensure that the surrounding area is well ventilated during this time.*

## REDUCED BURNING

**Please Note :**

**Classification of this appliance is for intermittent use.**

Lower or reduced burn rates are possible by reducing the air wash inlet control to a lower setting. Please note if the air wash control is fully closed the appliance will be starved of air and die down.

**WARNING :**

When wood is burnt slowly in a closed appliance, it produces moisture and tar, which will create condensation and deposits in the chimney. This effect can be minimised by burning hard for a short period, 15 to 20 minutes, twice a day.

*Please Note : To avoid chimney problems your appliance should not be burnt at a reduced burn rate without a period of fast burning.*

**WARNING :** Properly installed, with a suitable flue or chimney and operated and maintained, this appliance will not emit fumes into the dwelling. Occasional fumes when de-ashing and re-fuelling may occur. However, persistent fume emission is potentially dangerous and must be investigated by a HETAS registered engineer.

### **Stop using the appliance if you smell fumes or see smoke escaping.**

If fume emission does persist, the following immediate actions should be taken :

- Open doors and windows to ventilate room.
- Let the fire die or extinguish and safely dispose of fuel from the appliance.
- Check for flue or chimney blockage, and clean if required.

*Seek expert advice from your HETAS registered installer. Do not attempt to re-light the fire until the cause of the fume emission has been identified and corrected.*

### OVER FIRING & CHIMNEY FIRES

**DO NOT** over fire your appliance. Using flammable liquids or too much wood or firing the stove at maximum for prolonged periods may result in over-firing. If the chimney connector or casing glows red the appliance is being over-fired this may result in a chimney fire. If this occurs :

- **Call the Fire Service—Dial 999**
- **Immediately close all of the air inlets to the appliance, to reduce the air supply to the stove.**
- **Move items of furniture and combustibles away from the stove, to reduce a risk of fire and to allow access for the fire service.**
- **Ensure access to the loft space is available.**
- **Evacuate the property.**

The chimney fire may cause structural damage to the chimney. Do not use the appliance until the chimney and connector have been inspected and any damaged parts have been repaired or replaced. This should be done by a HETAS registered engineer.

### ASH REMOVAL

The appliance will require ash to be removed periodically but an ash bed of approximately 20mm (3/4") should be maintained. Ash may be removed with a small shovel whilst the fire is still lit by raking the embers of a low fire to one side of the firebox and carefully removing the ash, then repeating the procedure for the other side. Care must be taken not to risk burning of hands or household objects from falling embers.

The ash pan should be emptied at least twice a day or when the level of ash reaches the top of the ash pan. On no account should the ash be allowed to build up to touch the underside of the wood tray as this will greatly reduce the life span of the tray. When burning wood, it is acceptable to maintain an ash bed on top of the wood tray of approximately 20mm (3/4") without any un-due effect.

### WARNING :

**The ash can be very hot. Empty only into a metal container. Even if the ash appears cold, red-hot pieces of ash may be concealed and could easily start a fire or cause an injury**

# OPERATING INSTRUCTIONS

## AIR INLET CONTROLS

The Arrow Signature 5 stoves have two air inlet controls. The primary air inlet providing under draught to the base of the fire chamber through the control slider located under the oval at the base of the fire door. The air wash system, (secondary air) so called because its pre-heated high speed air, washes across the inner face of the door glass, keeping it clear. This also provides an over draught to the fuel bed.

## PRIMARY AIR

Air enters the appliance through the control on the bottom of the fire door. The Arrow Signature has a single control knob which slides left to right. Sliding the knob to the right (+), see Fig. 13, will increase the amount of air intake to the stove. To decrease, push the slider to the left (-) as in Fig. 14



Fig. 13. Fully Open Position



Fig. 14. Fully Closed Position

## AIR WASH SYSTEM

The air wash has an internal sliding plate with slots, housed in a cover plate, and is located above the fire door. Sliding the control knob to the right as far as it will go, achieves the fully open position, see Fig. 15. Sliding it to the left will shut off the air inlet slots as shown in Fig. 16.

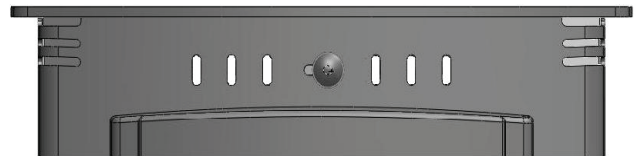


Fig. 15. Air Wash Fully Open Position

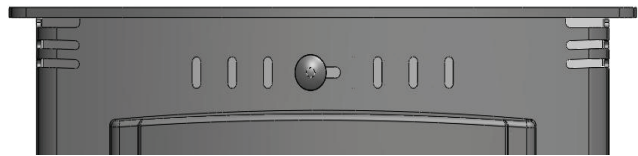


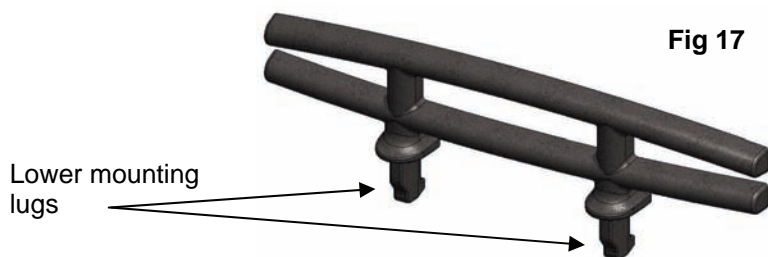
Fig. 16. Air Wash Fully Closed Position



## FUEL RETAINER BAR

A fuel retaining bar is supplied with the Signature 5 stove (Fig 17). For fitting please follow steps 1 to 3 detailed below..

**Please Note—This should be carried out when the stove is cold and unlit.**



### Installing the cast fuel retainer



Step 1



Step 3



Step 2

**Step 1,**  
Insert the cast fuel retainer into the fire box, through the door aperture at a slight angle as shown.

**Step 2,**  
Lower the fuel retainer bar so as to engage the lower lugs into the mounting slots in the stove body as shown

**Step 3,**  
Ensure the fuel retainer is sat fully down onto the front landing as shown

## OPERATING INSTRUCTIONS

---

### MULTI PURPOSE OPERATING TOOL

Your Aarrow stove is supplied with a multi purpose operating tool, used for adjusting the air inlet control and the removal of the ash pan. (See Fig 18)

### TO EMPTY THE ASH PAN

The Signature 5 stoves are supplied with a unique ash pan. To empty or remove the ash pan, open the fire door, fit the fork end of the operating tool into the ash pan slots and remove from the ash pit chamber.

Empty the ash into a suitable container and replace the ash pan into the stove, withdraw the operating tool and close the fire door.

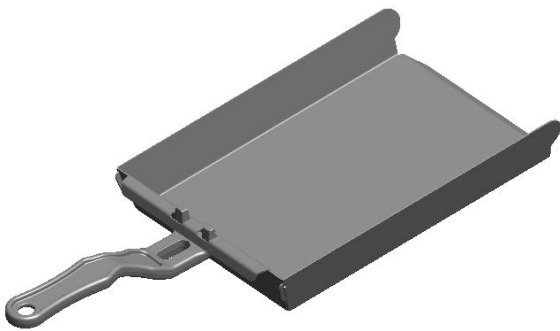


Fig. 18. Operating Tool & Ash pan

### AIR WASH CONTROL KNOB

The operating tool can also be used to adjust the air wash control knob. Use the fork end of the tool, place side onto the knob and tap in the desired direction. (See Fig. 19.)

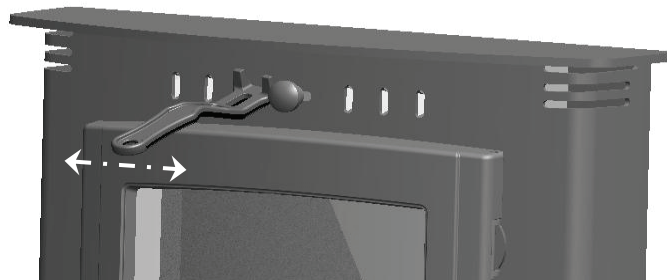


Fig. 19. Adjusting Air Wash Control  
( shown opening )

### MAIN FIRE DOOR HANDLE

A stove mitten is supplied with your Aarrow Signature 5 stove, this is provided for the operation of the fire door handle whilst the stove is in use. Care must be taken when opening and closing the fire door as any surrounding areas of the stove will be very hot.

**WARNING :**

Never attempt to open the fire door whilst the appliance is in use WITHOUT the use of the stove mitten or suitable gloves, serious injuries may occur.

Caution must be taken when re-fuelling the appliance, always keep the stove mitten away from naked flames and sparks.






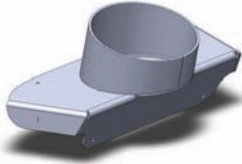

**Nickel plated door handle**

**The Main Fire Door Handle**









This handle may reach 100°C always use a stove mitten or the supplied Hot Glove.




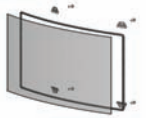








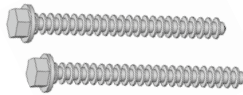
**OPTIONAL EXTRA / ACCESSORIES**

<b>Part Description</b>	<b>Visual Aid ( Not to Scale )</b>	<b>Signature 5 Inset</b>
<b>Aerosol Touch Up Paint</b>		<b>AFS 101</b>
<b>Gothic Door Tracery</b>		<b>SEB15 TRACEG</b>
<b>Lattice Door Tracery</b>		<b>SEB15 TRACEL</b>
<b>Flue Gather Kit (Includes Fixings)</b>		<b>5 INSET GATHER</b>
<b>Multi Fuel Upgrade Kit (includes Fixings)</b>		<b>MFKITINSET5</b>

## SPARE PARTS

Part Description	Visual Aid ( Not to Scale )	Signature 5 Inset
Replacement Manual		AFS1397
Air Wash Control Knob (Includes Washer)		AFS1405
Replacement Hot Glove		AFS1285
Throat Plate		AFS1402
Ash Pan		AFS1395
Rear Liner		AFS1410
Side Liner		AFS1409
Complete Liner set		AFS1408
Fuel Retainer		AFS1378
Operating Tool		AFS008
Rear of Body Face Rope Seal		AFS1407

## SPARE PARTS

Part Description	Visual Aid ( Not to Scale )	Signature Inset 5
Replacement Door Glass Gasket and Clips		AFS1365
Replacement Door Glass Kit (Includes Fixings)		AFS1386
Hinge Kit (Includes Fixings)		AFS1279
Fire Door Rope Kit & Glue		AFS1021
Fire Door Assembly, Complete		AFS1406
Fire Door handle Assembly		AFS1385
Wood Burning Tray		AFS1401
Tertiary Air Top (Includes Fixings)		AFS1403
Wood Cover Plates (Includes Fixings)		AFS1404
Replacement Primary Air Slider		AFS1369
Stove Fixing Bolts (M10 x 75mm)		AFS1434

### **Guarantee**

Once again we would like to thank you for buying an Aarrow Signature 5 Inset stove.

When you buy an **Aarrow** stove, you are not only buying a first class appliance you are buying a commitment from us to look after you and your appliance for as long as you want.

The **Signature 5** Inset stove comes with a **LIFETIME GUARANTEE** against splitting or cracking of the main body. The main body being defined as the steel outer casing and items fixed immovably to the casing. All other parts are covered by a one year no-quibble parts guarantee.

This guarantee shall not apply to any part that has been altered in any way, or which in our judgment has been subjected to misuse, neglect, accident, abuse and fair wear and tear.

Items which would be subject to fair wear or tear, firebox liner panels, fuel retainers, throat plate, door rope, door glass, grate or grate bars and gaskets are not covered by the guarantee. However, should you have any problems with your appliance, please contact your Aarrow stockist who will have the knowledge and facilities to help you.

**Aarrow (Arada Ltd)**, cannot guarantee items which are susceptible to breakage or damage through careless handling, dropping etc., or through misuse of the appliance by over firing, burning petroleum coke, etc. Nor can the guarantee be extend to deterioration of parts through fair wear and tear. Firebox linings, fuel retainer, throat plate, gasket materials and door glass are therefore not covered by the guarantee.

The guarantee is conditional upon the appliance being serviced and checked annually by a qualified heating engineer, with documentation to be retained and produced in the event of a claim being made.

**Claims are not valid where installation does not conform to appropriate building regulations.**

**The manufactures decision shall be final.**

**If your appliance proves to be defective as a result of faulty materials or workmanship during the guarantee period, we will repair or replace it FREE OF CHARGE as long as the stove has been installed according to this manuals instructions and the Final Installation Check List on page 15 has been completed and signed by a suitably qualified engineer at the time of installation.**

**USE OF SPARE PARTS OTHER THAN THOSE SUPPLIED BY AARROW WILL INVALIDATE THE APPLIANCE WARRANTY.**

**Aarrow WILL NOT BE RESPONSIBLE FOR ANY CONSEQUENTIAL OR INCIDENTAL LOSS, DAMAGE OR INJURY HOWEVER CAUSED.**

All guarantee periods commence on the date of purchase and are non-transferable.

Our guarantee is offered as an additional to your statutory rights.

If you think your stove is not working correctly or in the event of a breakdown, **Please call your local dealer.**

When you call your dealer they will want to know:

1. Your Name, Address, post code and telephone number.
2. Your stove's serial number.
3. Clear and concise details of the fault.

This installation and operating manual gives sufficient details to enable the appliance to be installed and maintained. If further information is required, our technical helpline will be pleased to help.

Please telephone: **0844 8475107** -or -  
email: **info@arada.uk.com**

**Please Note:**

**The appliance serial number can be found stamped into the casing of the main stove body, centrally just below the bottom edge of the fire box door aperture.**





## *Lifetime Guarantee*

*For your peace of mind*

**Arrow stoves** give a Lifetime Guarantee against manufacturing defects of the main body\* of its Signature 5 Inset stove. Additionally, all other parts are covered by a one year no quibble replacement guarantee. This guarantee covers replacement of the item only and does not extend to any other costs, including labour, incurred in its replacement. Documentation must be retained and produced in the event of a warranty claim. This guarantee specifically does not cover accidental damage, misuse, general wear & tear. The use of non Arrow replacement parts will invalidate your warranty. For full details, contact your local Arrow retailer. All guarantees are in addition to your statutory rights. Please see page 31 for further information regarding the lifetime guarantee.

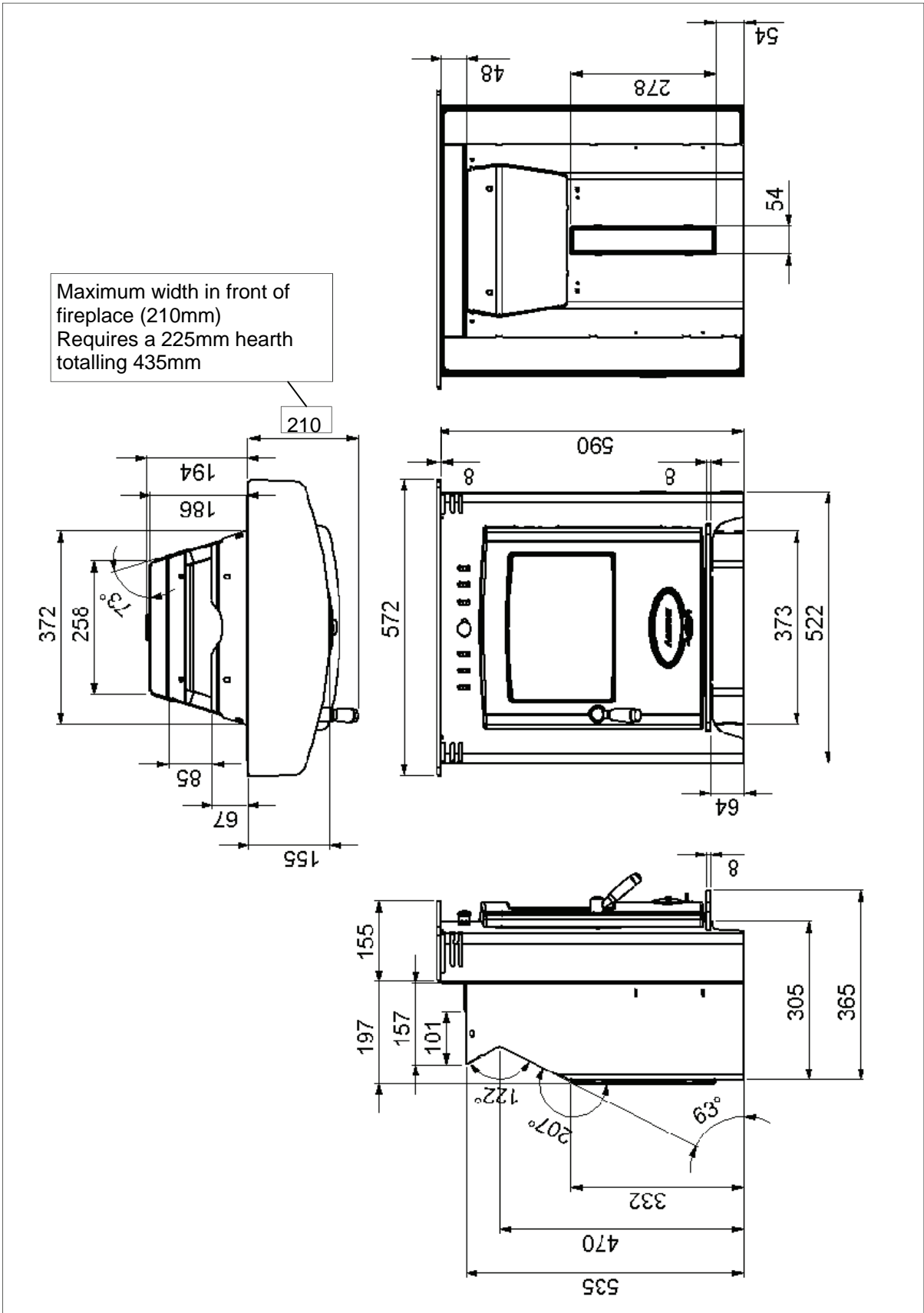
\* The main body defined as the steel outer casing and items fixed immovably on to its casing.



*The Signature 5*



# GENERAL DIMENSIONS



**Final Factory Check list**



<p><b>Stove Model :...’ SIGNI 5 W’</b></p> <p><b>Serial No. ....</b></p>
--------------------------------------------------------------------------

<b>Quality / Finish</b>	
<b>Parts</b>	
<b>Wood Burning Tray</b>	
<b>Wood Cover Plates (Internal &amp; External Fitted)</b>	
<b>Cast Fuel Retainer</b>	
<b>Firebox Liners</b>	
<b>Throat Plate</b>	
<b>Air Wash (function)</b>	
<b>Door Catch / Nickel Door Handle</b>	
<b>Ash Pan</b>	
<b>Operating Tool</b>	
<b>Operating &amp; Installation Manual</b>	
<b>Heat Resistant Hot Glove</b>	
<b>Masonry Fixing Screws</b>	

***I’ve checked it  
and its O.K !***

Assembled By.....

Checked By.....

Date of Purchase.....

Name and Address of Supplier.....

.....  
.....  
.....

**Arada Ltd  
The Fire Works  
Millway Industrial Estate  
Axminster  
Devon  
EX13 5HU  
United Kingdom**

**Tel: +44(0)1297 35596 Fax: +44(0)1297 35900 www.arada.uk.com**