



---

# ECOBURN™

LESS FUEL • MORE HEAT • CLEANER ENVIRONMENT

## RANGE OF STOVES



**PLEASE RETAIN THIS GUIDE FOR FUTURE REFERENCE**

---

**BK061**

EN 13240:2001+  
Amd. A2:2004

Rev 05  
August 2009  
Part No. AFS1363





---

Congratulations on your choice of an Aarrow Stove.

More than 20 years experience has been put into the development of our Ecoburn range to ensure ultimate performance and years of trouble free use and enjoyment.

Every detail of the stove has been carefully designed and engineered which is why we are so confident in the reliability of our products.

Should you have any questions about our Ecoburn stoves that are not covered by this manual, please contact the Aarrow retailer in your area, or call our technical support department on **0844 847 5107**

---

All Aarrow Ecoburn stoves are approved to European Standard EN 13240 and CE marked.

These appliances listed within this manual have been approved by *HETAS Ltd* as an intermittent operating

**Copyright 2008**

Arada Ltd

This booklet has copyright and may not be copied in whole, or part, or used for any purpose other than that for which it is supplied without express written consent from Arada Ltd

**PLEASE NOTE—** *Arada has a policy of continuous product development and therefore we reserve the right to amend the specification without prior notice.*

*Due to printing cycles, items or options may be described before they are generally available or after they have ceased, so please check with your retailer or dealer.*

---

# Contents

---

	Page No.		Page No.
<b><u>INTRODUCTION</u></b>		<b><u>SERVICE &amp; MAINTENANCE</u></b>	
Warning Notice	4	Annual Maintenance	17
Safety Notices	5	Cleaning	17
The Principle Of The Stove	5	Chimney Sweeping	17
Check List	6-7	Door Glass	17
Data Plate Information	7	Outer Finish	17
Technical data	8	Summer Storage / Non Usage	18
<b><u>INSTALLATION</u></b>		Adjusting The Door Hinges	18
General Precautions	9	Fuel Retaining Bar-Inspection	18
Handling	9	Fire Door Rope Replacement	19
Hearth	9	Fire Door Glass Replacement	19-20
Combustible Materials	9	Primary Air Oval Inspection / Cleaning	20
Air For Combustion	9	Service Record	21
Fitting The Flue Outlet & Hotplate	10	<b><u>OPERATING INSTRUCTION</u></b>	
Sealing The Terminals	10	Fuel Types	22
Flues & Chimneys	10-13	Lighting The Stove	22
Adjusting The Self Levelling Feet	14	Burning Wood	23
Firebox Liner Panels	14-15	Reduced Burning	23
Final Check	15	Over Firing & Chimney Fires	24
Building Control Consent Checklist	16	Ash Removal	24
		Air Inlet Controls (Primary/Air wash)	25
		Fuel Retainer Bars	25
		Multi Purpose Operating Tool	26
		Main Fire Door Handle	27
		<b>OPTIONAL EXTRA/ACCESSORIES</b>	28
		<b>SPARE PARTS LIST</b>	29-31
		<b>GUARANTEE</b>	32-33
		<b>FACTORY CHECK LIST</b>	34

---

---

# WARNING

IT IS A LEGAL REQUIREMENT THAT THE INSTALLATION OF ALL NEW OR REPLACEMENT, WOOD OR SOLIDFUEL HEATING APPLIANCES ARE REQUIRED TO OBTAIN BUILDING CONTROL APPROVAL FROM YOUR LOCAL AUTHORITY OR THE INSTALLATION WORK MUST BE CARRIED OUT THROUGH A GOVERNMENT APPROVED COMPETENT PERSONS SCHEME SUCH AS OPERATED BY HETAS.

IF IN DOUBT, CONTACT HETAS LIMITED  
TELEPHONE NUMBER : 0845 634 5626  
[www.hetas.co.uk](http://www.hetas.co.uk)

THIS STOVE MUST NOT BE CONNECTED  
TO A SHARED FLUE SYSTEM

**TO ALL USERS**  
PETROLEUM COKE  
SOME OF WHOSE BRAND NAMES ARE  
**'CALCO', 'PETROCOKE' AND 'WONDERCO'**  
MUST NOT BE BURNED IN THIS APPLIANCE

BITUMINOUS HOUSE COAL  
SHOULD NEVER BE USED IN YOUR STOVE

TO USE THESE FUELS WILL INVALIDATE  
THE APPLIANCE GUARANTEE.

IF IN DOUBT CONTACT THE SOLID FUEL ASSOCIATION  
TELEPHONE NUMBER 0845 601 4406  
[www.solidfuel.co.uk](http://www.solidfuel.co.uk)

### SAFETY

A fireguard conforming to BS 8423:2002 should be used in the presence of children and old or infirm people.

Please note, this appliance should be used with the fire door closed at all times except when re-fuelling or de-ashing.

**Do not use aerosol sprays or any other flammable materials near the appliance under fire.**

**Do not fit an extractor fan in the same room as the appliance.**

**Fire cement is caustic, hand and eye protection should always be worn, prolonged contact with the skin should be avoided.**

**Arada Ltd will not be responsible for any consequential or incidental loss or injury however caused.**

Before continuing any further, with the installation of this appliance please read the following guide to manual handling.

- Always obtain assistance when lifting the appliance
- When lifting always keep your back straight, bend your legs not your back
- Avoid twisting at the waist. It is better to reposition your feet.
- Avoid upper body/top heavy bending. Do not lean forwards or sideways when handling the fire
- Always grip with the palms of your hands do not use your fingertips for support
- Always keep the stove as close to the body as possible as this will minimise the cantilever action.
- Use gloves to provide additional grip.

### THE PRINCIPLE OF THE STOVE

Your **Arrow** stove is built to the highest standard of craftsmanship using the best materials and the most modern equipment available. It is a highly efficient and sophisticated piece of machinery and when properly installed and operated should provide a lifetime of heating satisfaction.

Safety is the most important consideration when installing your fire. If not properly installed and operated a house fire may result. Installation must comply with the Building Regulations and conform to all safety standards.

**Arrow** produce a variety of appliances ranging from the traditional to the modern in style and appearance, all bristling with 'High Tech' features.

The fire door is fitted with a special high temperature ceramic glass panel through which the fire can be viewed.

The stove is lined with firebricks or heat reflective panels which ensure complete combustion and provide a good heat store to even out fluctuations in burning.

An internal throat plate produces turbulence to encourage secondary combustion and direct the flue gas around the whole upper firebox before allowing it to escape up the chimney.







**Arrow** stoves are also fitted with an 'air wash' so called because it provides a curtain of high speed preheated air behind the glass to help keep it clean and provide secondary air/over draught.

The provision of two inlets on all stoves gives a wide range of primary / secondary air, under draught/over draught combinations. The optimum setting will only be established by experience in firing the appliance, and will depend on the type of fuel, the position of the appliance in the house, and condition of the chimney etc.



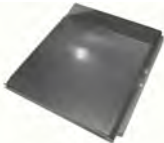

## CHECK LIST

---

Inside the appliance body you should find the following:

Part Description & Visual Aid (not to scale)	Aarrow ECB 5	Aarrow ECB 7	Aarrow ECB 9	Aarrow ECB 11
1. Fuel Retainers 	2	2	2	2
2. Throat Plate 	1	1	1	1
3. Flue Spigot 	1, (4")	1, (5")	1, (5")	1, (6")
4. Hot Plate 	1, (4")	1, (5")	1, (5")	1, (6")
5. Ash Pan 	1	1	1	1
6. Operating Tool 	1	1	1	1
7. Instruction Manual 	1	1	1	1

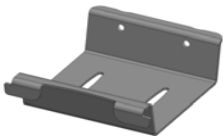
Inside the appliance you should find the following :

Description & Visual Aid (not to scale)	Aarrow ECB 5	Aarrow ECB 7	Aarrow ECB 9	Aarrow ECB 11
8. Side Liners 	2	2	2	2
9. Rear Liners 	1	2	2	2
10. Wood Burning Tray 	1	1	1	1
11. Stove Mitten ( Hot Glove) 	1	1	1	1
14. Fire Door Handle (Nickel Plated) 	1	1	1	1

## Data Plate Information

Please Note— All Ecoburn stoves are fitted with a data plate located on the bottom right hand side of the stove. The data given is that registered on the HETAS website on the output and performance of the stove.

The CE mark indicates that the stove performance has been independently certified by a competent body.

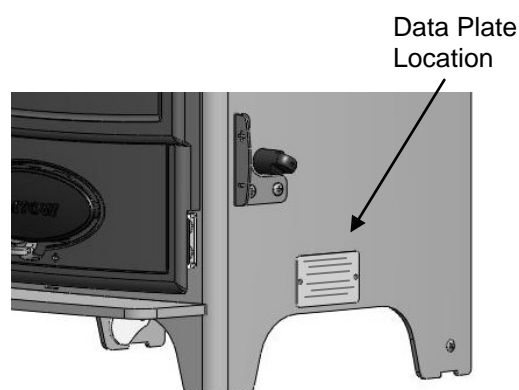

## TECHNICAL DATA

---

TECHNICAL DATA	Aarrow ECB 5	Aarrow ECB 7	Aarrow ECB 9	Aarrow ECB 11
Nominal Heat Output (Kw)	5.1	6.1	8.8	11
Efficiency Nett (%)	74.7	72.1	71.6	74.7
Mean Flue Gas Temperature (c)	306	363	364	370
Mean CO Emission @ 13% O2 (%)	0.58	0.58	0.68	0.71
Flue Mass Gas Flow (g/s)	4.4	4.9	6.9	6.9
Minimum Distance To Combustible Materials (mm)**	Rear- 625 Sides- 525	Rear- 650 Sides- 450	Rear- 750 Sides- 500	Rear- 800 Sides- 500
Height (mm)	522	558	600	605
Width (mm)	397	476	586	672
Depth (mm) (Inc. Handle)	388	386	396	442
Height To Centre Of Rear Flue (mm)	424	449	485	478.5
Depth From Back To Centre Of Flue (mm)	94	109	102.5	141
Flue Diameter (mm)	102 (4")	127 (5")	127 (5")	152 (6")
Weight Packed (Kg)	57	68	79	106
Weight Nett (Kg)	54	64	75	101

**\*\*NOTE :** If the optional convector kit is to be fitted to the stove, the minimum distance to combustible materials is REDUCED to the following dimensions :

Minimum Distance To Combustible Materials (mm) With Convector Kit Fitted	Rear- 450 Sides- 450	Rear- 500 Sides- 450	Rear- 410 Sides- 380	Rear- 550 Sides- 460
--	-------------------------	-------------------------	-------------------------	-------------------------



## GENERAL PRECAUTIONS

*Note : All local regulations, including those referring to National and European standards need to be complied with, when installing the appliance.*

The Building Regulations for England and Wales 2000 ref Approved Document J 2002 edition (issued by the DTLR).

The Building Standards (Scotland) (Consolidation) Regulations.

Detailed recommendations for installation of appliances, chimneys and flues are outlined in the current issue of the following British Standards : BS6461, BS8303 & BS4543.

***Any Manufacturer's Instructions must not be taken as overriding statutory requirements.***

***Before any installation work is undertaken consideration must be given to the Health and Safety at Work Act 1974. Safe working practices should be followed at all times.***

During installation ensure that adequate precautions are taken to avoid unnecessary risk to yourself or any householder. In particular the danger from caustic nature of the fire cement should be avoided by using these accepted methods :

- Wear gloves when handling fire cement
- Wear goggles when chiselling or looking up chimneys.

Make sure that Building Regulations are adhered to during installation along with any local by-laws. In the case of heating systems make sure that the pipe work is correctly bonded to ensure electrical earth continuity.

## ASBESTOS

All Aarrow stoves contain no asbestos in their manufacture or construction. If there is a possibility of disturbing any asbestos in the course of installation, then please seek specialist guidance and use appropriate protective equipment.

## HANDLING

The safe handling guidelines are set out on page 5 of this manual, to make movement easier, internal fittings, fuel retainers, grates, firebox liners, flue outlets, hot plates, throat plates etc, can be removed. Care should be taken to make sure that the hinges are not damaged during installation.

## HEARTH

The stove shall be installed on a floor with adequate load bearing capacity. If the existing construction does not meet this prerequisite, suitable measures (e.g.: load distributing plate) should be taken to achieve it.

Ideally, the appliance should stand on a constructional hearth of non-combustible materials not less than 125mm (5") thick conforming to Building Regulations.

Dimensions of the hearth should project at least 300mm (12") forward of the front of the appliance and 150mm (6") at the sides.

The surface of the hearth should be free of combustible materials. In most buildings with solid concrete or stone floors, the requirement will be met by the floor itself, but mark the hearth to ensure floor coverings are kept well away or use different levels to mark the hearth perimeter.

## COMBUSTIBLE MATERIALS

Please view the technical data (see page 8) and observe the **minimum** distance to combustible materials, which is applicable to your stove model. Ideally, adjacent walls should be of suitable non combustible construction, preferably brickwork. In large fireplaces take care that any supporting beam is protected by a 13mm (0.5") sheet of Masterboard or Superlux spaced 13mm (0.5") off the surface with strips of non combustible material. Make sure that there is a gap between an un-insulated flue system and any combustible material. This gap must be at least 3X the outside diameter of the flue pipe, or 1.5X the flue diameter to non combustible surfaces. See illustration on page 13.

## AIR FOR COMBUSTION

There must always be a permanent means of providing air for combustion into the room in which the stove is installed. A permanent vent with a total free area of at least 550mm<sup>2</sup> for every KW rated above 5KW should be connected directly to the outside air or to an adjacent room which itself has a permanent vent of the same size direct to the outside air. The positioning of any air vent must be so that it cannot be liable to blockage or obstruction. **Please note** : The fitting of an extractor fan to either of these rooms is not recommended. Please see note on page 11.

## INSTALLATION

### FITTING THE FLUE OUTLET AND HOT PLATE

The flue outlet spigot is found packed inside the appliance. The hot plate (blanking plate) is supplied fitted to the top opening and is removed by turning clockwise (as is the flue outlet).

Smear a very thin layer of fire cement on the mating faces of the flue outlet and the hot plate. Fit the outlet to the appliance in the desired position.

Lock into place by rotating anti-clockwise and tighten by tapping with a block of wood and mallet from inside of the appliance. Similarly, fit the hot plate (blanking plate) to the unused opening. Clean off any surplus fire cement.

Place appliance on the hearth and make sure that it is level and does not rock.

Connect the chimney ensuring all joints are sealed with fire cement.

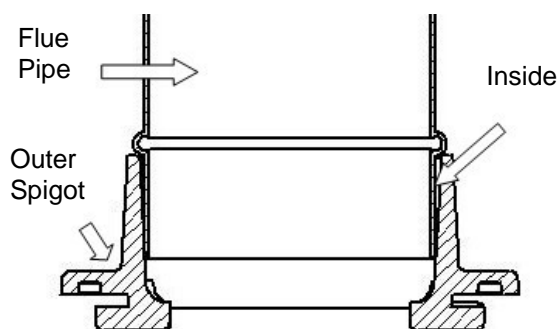

Fig. 1. Flue & Spigot Fitting

Note : The flue pipe must be fitted inside the outlet spigot. Failure to do so could result in the spillage of condensation running down the flue.

( See Fig. 1 )

### SEALING OF TERMINALS

If an add in boiler is not to be fitted, please ensure that the two partially cut circular terminals (located on the rear of the appliance) are sealed with fire cement, and thus preventing surplus air entering the firebox, resulting in less efficiency and poor fuel consumption.

### FLUES AND CHIMNEYS

The flue draw is critical on any installation and should be checked to ensure that it matches what is specified. If it is higher than recommended, provision must be made to correct the over draw. The draw can vary in different weather conditions and the customer should be made aware of this. Failure to correct an over-drawing flue will invalidate the warranty.

Please remember that chimney draught is dependent on four main factors :

- Flue gas temperature
- Flue height
- Flue size
- Flue terminal

The stove must be connected to a suitable and efficient flue so that products of combustion (fumes) from the stove are expelled to the outside air. To ensure a good up draught it is important that the flue gases are kept warm and that the flue size suits the stove. The termination of the outlet at the top of the flue also needs to comply with Building

Regulations. The minimum effective height of the flue must be at least 4.5 metres from the top of the stove to the top of the flue outlet. When warm the flue draught should be between 0.1 to 0.2 mb.

A chimney may comply with regulations but could still be subject to down draught and similar problems. A chimney terminating above the ridge level is generally less likely to suffer such problems.

If a new chimney is being provided it should fully comply with the relevant Building Regulations that specify the requirements for solid fuel burning installations. Suitable types of chimney include the following :

**Masonry Chimney** : Built with clay or concrete liners, or a chimney block system meeting Building Regulations. These types of chimney should be installed in accordance with the Building Regulations and BS 6461:Part 1.

**Factory Made Insulated Chimney** : Complying with BS 4543:Part 2 (often called "Class 1 prefabricated metal chimney"). These types of chimney should be installed in accordance with Building Regulations and BS 7566: Parts 1 to 4.

Due to the gradual introduction of Europe Chimney Standards chimneys will be specified according to their performance designation as defined in BS EN 1443 that covers the General Requirements for chimneys. The minimum performance designation required for use with solid fuel burning stoves is T450 N2 S D3.

The flue and chimney installation must be carefully checked by a competent person before fitting the stove to ensure it is suitable and will work safely.

If the chimney is old (ie: built of brick or stone without a liner) or being opened up for reuse additional checks and smoke testing as described in Appendix E of the Approved Document J 2002 Edition should also be carried out to ensure the flue and chimney are good operating condition.

Check the existing flue is in good condition with suitable access for collection and removal of debris. If the flue size is more than 225mm (9") diameter or 200mm (8") X 200mm (8") square, a suitable lining of 150mm (6") diameter should be fitted, or if the flue length is over 5.5 metres one size larger than the appliance outlet should be fitted. This should be a double skin stainless steel flexible liner that is independently certified for use with solid fuel. Details of suitable linings for use with wood & solid fuel are given in the Official HETAS guide that can be viewed on their website at [www.hetas.co.uk](http://www.hetas.co.uk).

It is also important that suitable flue pipe complying with the Building Regulations is used to connect the stove to the flue in the chimney and that suitable access is provided into the flue for regular inspection and sweeping of the flue ways.

The installer should comply with Building Regulations requirements in respect of providing a Notice Plate giving details on the chimney, flue lining, hearth and fireplace installation. Approved Document J of the Building Regulations for England & Wales is available from The Stationary Bookshops and can also be viewed at the ODPM website at [www.safety.odpm.gov.uk/bregs/brads.htm](http://www.safety.odpm.gov.uk/bregs/brads.htm).

Details on the relevant Building Regulations and BS British Standards are given in the "General Precautions" section of these instructions.

Chimneys should be as straight as possible. Horizontal runs should be avoided except where

the rear outlet of the appliance is used, in which case the horizontal section should not exceed 150mm (6") in length.

If the stove appears to be working hard but produces very little output to the room it is likely that excess draw is present in the chimney, and that heat is being sucked out of the appliance and up the chimney. If this is the case we recommend the fitting of a draught stabiliser in preference to a flue damper, in the interest of safety and efficiency.

### FOR ALL APPLIANCES

Access for cleaning the flue should be incorporated in the system other than through the appliance (eg: a soot door or access through register plate). Purpose made soot doors and inspection lengths are available from manufacturers of all systems. Ensure that the whole length of the flue can be reached from the soot door.

***Note: if the appliance is fitted with a draught stabiliser or if one is fitted to the flue pipe or chimney in the same room as the appliance, then the permanent air entry opening (or Openings) should be increased by 300 mm<sup>2</sup> for each KW of rated output.***

**For advice on flues and chimneys contact:**

**NACE (National Association of Chimney Engineers) Telephone : 01526 322555  
[www.nace.org.uk](http://www.nace.org.uk)**

**OR**

**NACS (National Association of Chimney Sweeps) Telephone : 01785 811732  
[www.chimneyworks.co.uk](http://www.chimneyworks.co.uk)**

**OR**

**HETAS (Official Body To Approve Solidfuel Domestic Heating Appliances)  
Telephone : 0845 6345626  
[www.hetas.co.uk](http://www.hetas.co.uk)**

## INSTALLATION

---

**NOTE** - Under no circumstances should this appliance be connected to a shared flue system, that serves any other heating appliance.

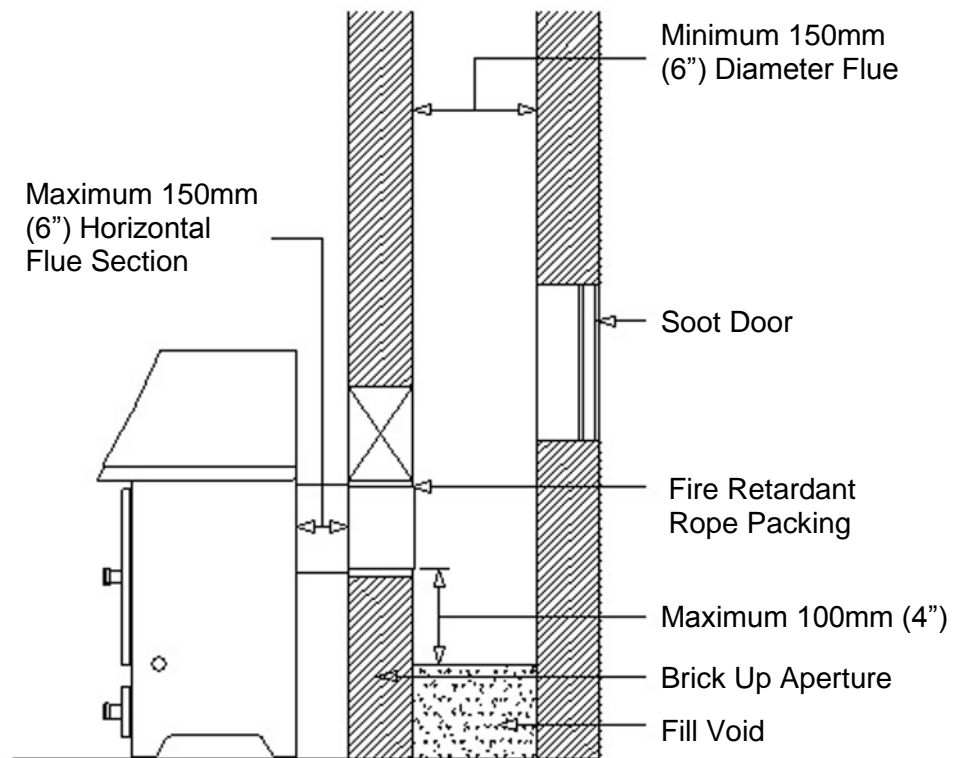

**TYPICAL REAR FLUE OUTLET (as per BS 8303-1)**

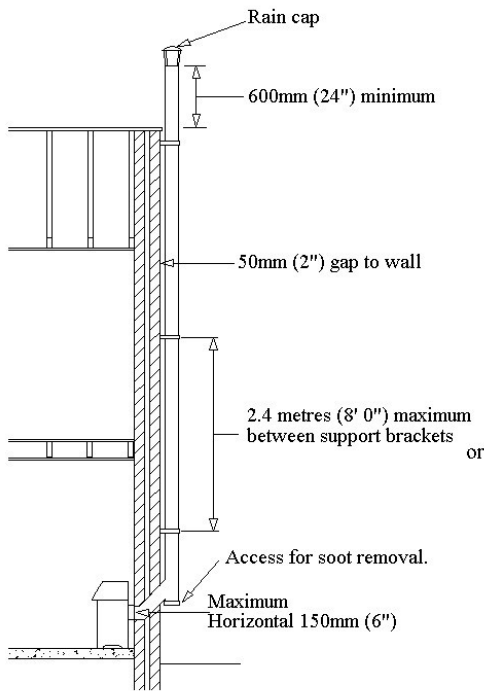

**Typical Metal Insulated Chimney System**  
 Installed To The Chimney Manufactures  
 Instructions In Compliance With Building Regulations  
 And BS 7566 Part 1 to 4

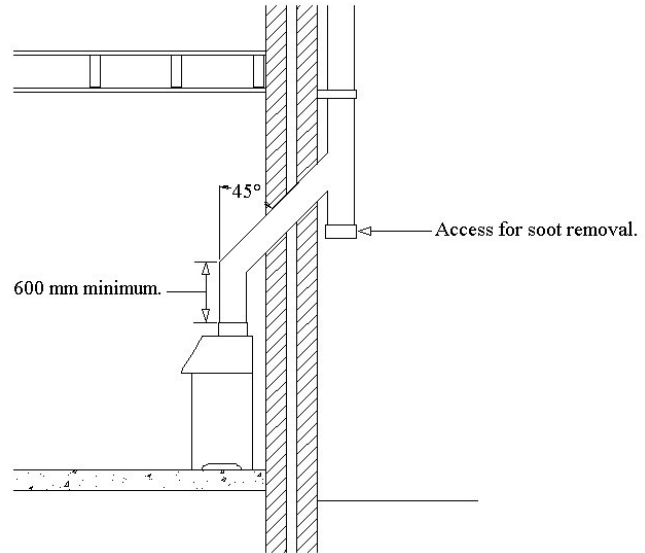

## PLAN VIEW OF REGISTER PLATE AND CLEARANCES FOR NON INSULATED FLUES

(Plan View Of Steel Register Plate, 1.5mm Thick Minimum )

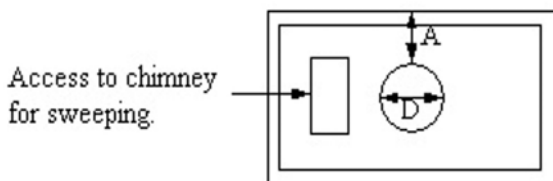

A (Minimum clearance for non-insulated flue) =  
 $1.5 \times D$  to a non-combustible surface/material  
 or  
 $3 \times D$  to a combustible surface/material

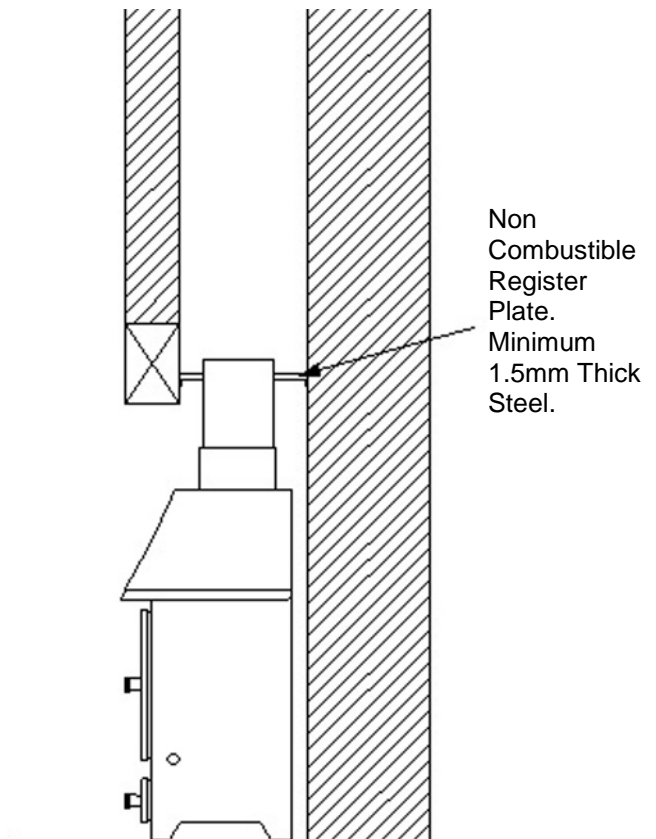

**TYPICAL TOP FLUE OUTLET (as per BS 8303-1)**

## INSTALLATION

---

### ADJUSTING THE SELF LEVELLING FEET

The Arrow Ecoburn stoves are equipped with adjustable rear levelling feet, these are ideal for use where the hearth surface is not flat or level.

Adjustment is as follows :

- Position the stove on the hearth into its final resting place, ensuring room for the flue connections etc.
- On the rear leg of the stove, loosen the pozi screw, and rotate the inner 'cam' shaped levelling foot until this touches the hearth. (see fig. 2.)
- Re-tighten the pozi screw. Check the stove is level with a spirit level.
- Repeat for the other rear leg.



Fig. 2. Adjusting The Rear Feet

### FIREBOX LINER PANELS

The Arrow Ecoburn stoves use firebox liner panels to the sides and back. The throat plate sits on top of the sides and rear panels. These should come fitted to your stove, if however they are not, proceed as follows to fit them.

- Open the fire door.
- Remove the two round front fuel retaining bars, by lifting one end free of the bracket and sliding the remaining end out from the bracket.
- Set the small liner (s) into the back of the firebox.
- Insert the side liner panels. (See Fig. 3)
- Fit the throat plate with the single bend and two cut outs to the front facing up. The projecting lugs sit on top of the side liners. The long centre tab on the back edge rests on the rear liners. The shorter turn down tabs against the vertical face. (See Fig.4 & 5)
- Replace the front fuel retaining bars.

**Note: Neither the rear firebox liners nor the side firebox liners are 'handed', both faces are suitable for direct contact with the fire bed.**

**Note : Cracking of the liner panels does not effect efficiency.**

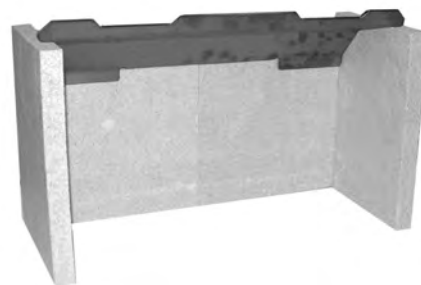

Overall View Of Liners & Throat Plate Assembly

## INSTALLATION

---

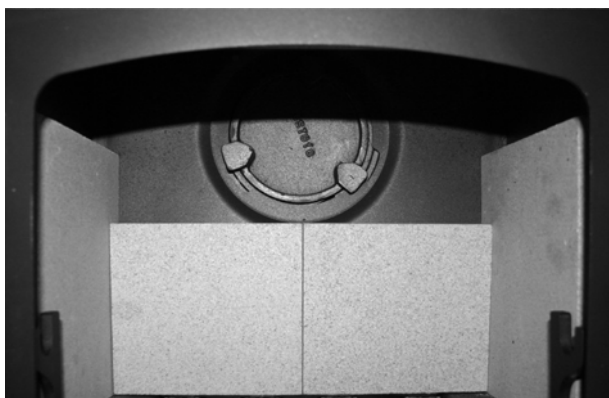

Fig. 3. Liners Inserted

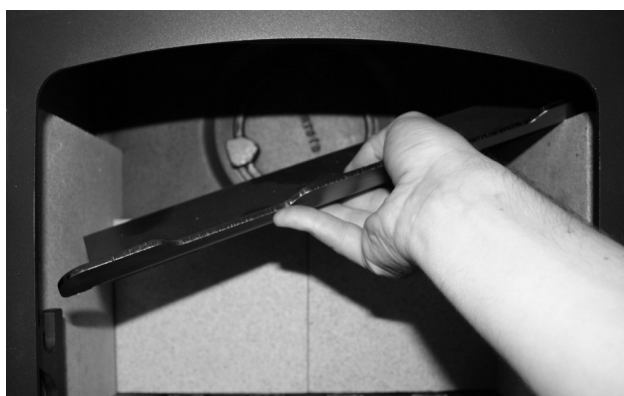

Fig. 4. Inserting The Throat Plate

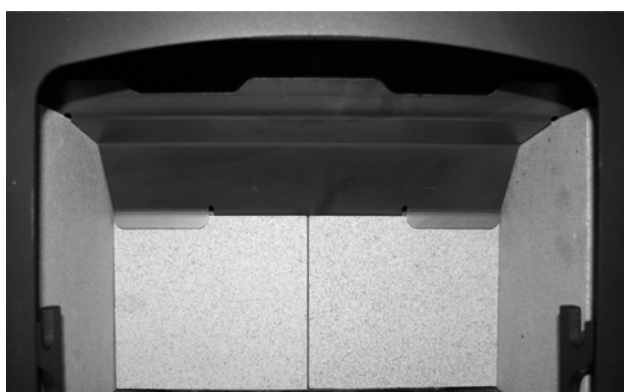

Fig. 5. Liners & Throat Plate Correctly Fitted

### FINAL CHECK LIST

Before handing over the installation to the customer it is a requirement under Document J that the appliance is lit and the functioning of the chimney system is checked for satisfactory operation.

- **Be sure that the chimney is operating and ALL smoke and fumes are vented to the atmosphere through the chimney terminal.**
- **Check all joints and seals.**
- **Clean the outside of the appliance to prevent any stains becoming burnt on.**
- **Check the flue draught which should read 1—2mm, or 0.1—0.2 mbar.**
- **If Building Control Consent route is being sought please complete the check list on page 17.**
- **For a registered Competent Persons Scheme, such as HETAS, please complete the Certificate Of Compliance, which is used for checking and reporting the installation as imposed by the Government**
- **Explain the controls and operation of the appliance to the customer.**

The following details **must** be checked and completed in full by the installer at the time of installation. Please answer all questions as fully as possible. **Arrow stoves** cannot be held responsible for the chimney or installation.

**BUILDING CONTROL CONSENT CHECKLIST**  
**Hearths, Fireplaces, Flues and chimneys**

This checklist is to ensure hearths, fireplaces, flues and chimneys are satisfactory, and show what you have done to comply with the requirements of the Building Regulations 2000 approved Document J 2002

1. Building address where work has been carried out .....	
.....	
2. Identification of hearth, fireplace chimney or flue	
3. Firing capability: solid fuel / wood /gas.	
4. Intended type of appliance. State model and output.	
5. Ventilation provision for the appliance: State type and area of permanently open vents.	
6. Chimney or flue construction a, State the type or make and whether new or existing b, Internal flue size (and equivalent height, where calculated natural draught gas appliances only) c, If clay or concrete flue liners used confirm that they are correctly jointed with socket end uppermost and state jointing materials used. d, If an existing chimney has been refurbished with a new Liner, Type and make of liner fitted. e, Details of flue outlet terminal and diagram reference. Outlet Details: / Complies with: f, Number and angle of bends g, Provision for cleaning and recommended frequency.	
7. Hearth. Form of construction, new or existing?	
8. Inspection and testing after completion Test carried out by: Test and results Flue Inspection Appliance (where included) spillage	Visual Sweeping Coring ball Smoke
I/We the undersigned confirm that the above details are correct. In my opinion, these works comply with the relevant requirements in part J of Schedule 1 of the Building regulations.	
Print name and title.....Profession.....	
Capacity.....Telephone No. ....	
Address.....Postcode.....	
Signed.....Date.....	
Registered member of.(e.g. Gas Safe (CORGI), OFTEC, HETAS, NACE, NACS)	



## SERVICE & MAINTENANCE

---

### ANNUAL MAINTENANCE

*It is important that your appliance is regularly serviced in accordance with these instructions. This should be carried out at least annually by a qualified person and should consist of the following :*

### CLEANING

**Important;** Under some circumstances soot can quickly build up on the throat plate and adjacent areas. The throat plate should be removed and checked monthly, and any debris stripped off. Similarly, clean the upper surface of the firebox.

Remove the firebrick linings and throat plate, inspect all rope gaskets on doors, glass etc, and re-order any items that may need replacing from your **Aarrow** dealer.

With a wire brush clean inside the appliance paying particular attention to the small inlet holes of the air wash on the inside, above the fire door.

Sweep the chimney and confirm that it is sound. Examine all joints in the flue pipe etc, and re-seal if necessary. Re-assemble and leave with the air inlet and air wash control about half way open. This will allow a free flow of air through the appliance thus preventing moisture and condensation from building up inside the stove and chimney.

### CHIMNEY SWEEPING

Sweeping should be carried out with an appropriate sized bristle brush and rods to suit chimney size and type. As with all appliances regular sweeping of the flue is essential to avoid danger of blockage and the escape of poisonous fumes. Access for cleaning should also be incorporated in the chimney (e.g.. Soot door or access through the register plate).

Any existing chimney should be swept prior to installation of the appliance, and swept again a second time **within one month** of regular use after installation to establish frequency of sweeping required. This should be done by a competent person such as a NACS chimney engineer who will provide a Certificate Of Chimney Sweeping. The whole flue way including the outlet must be swept at least twice per burning season. It is important that the flue ways, flue pipe and chimney

be cleaned prior to lighting the fire after a prolonged shut down period.

### DOOR GLASS

The door glass should remain clear during normal burning. However, under certain conditions, such as burning at a low rate or damp wood, or overnight burning, the glass may become somewhat blackened. To remedy this, operate the appliance at a fast rate. Alternatively when the stove is cold, open the door and clean the inside face of the glass with a damp cloth or with glass cleaner (available from fire stockists). A piece of cloth moistened with vinegar and dipped in wood ash (**not coal ash**) will provide a good soft scourer to remove the soot without scratching the glass.

### OUTER FINISH

The outer finish of the appliance is a durable high temperature paint. It is best cleaned, by brushing down, with a clean shoe brush. Do not allow moisture to remain on the appliance whilst cold or surface rust may form.

The high temperature paint should not require attention for some time, depending on use. The hotter the fire burns the sooner repainting will be necessary. Aerosol tins of paint are available for complete refurbishing.

Before repainting make sure that the fire is out and the stove is cold.

- Remove the door glass
- Lightly wire brush, or rub with wire wool, the body of the appliance to remove any loose paint or rust.
- Mask or remove items such as brass work.
- Any adjacent brickwork, mantelpiece, hearth etc, should be carefully masked for quite a distance around the appliance. This precaution is to prevent discolouration of the surrounding brickwork or wall paper etc.

**Re-spray in a well ventilated area, avoid breathing the vapour. Refer to safety instructions on paint cans.**

- When the paint is dry refit the door glass & any other parts previously removed.
- Leave the appliance for eight hours before lighting a fire.
- Burn slowly for the first four hours, then build up heat slowly to gradually cure paint.

*Note: Use genuine Aarrow touch up spray as some paints interact. This could ruin the finish and invalidate the guarantee.*

### SUMMER STORAGE / NON USAGE

Please ensure that your stove is left clean and moving components are well lubricated for the summer months (during periods of prolonged non use). If possible store the throat plate outside of the stove, check all moveable components, at regular intervals, to ensure they are moving freely.

Allow air movement through the stove, by opening the air wash and primary air inlet (s) controls to about half way open or leave the door ajar. This will allow a free flow of air through the appliance thus preventing moisture and condensation forming inside the stove and chimney. This preventative maintenance will ensure your stove stays in the best condition for the coming winter months.

### ADJUSTING THE DOOR HINGES

Once the appliance has been under fire for a period of time the fire door may appear to have moved out of alignment in relation to the door aperture or catch. This is quite normal and due to the settling of the casting.

The fire door can be re-aligned as follows :

- When the appliance is cold, open the fire door so that it is at right angles to the front of the stove.
- Lift the fire door up off its hinges.
- Gently tap the hinge pins in the direction to compensate for the misalignment. (Fig. 6)
- Re-fit the door and check to ensure it now sits square to the body; if not repeat the above steps.

If the fire door needs to be raised, please follow :

- When the appliance is cold, open the fire door so that it is at right angles to the front of the stove.
- Lift the fire door up off the hinges.
- Drop one washer on the top and bottom hinge pins.

- Refit the door and check.

**Please Note : There is no adjustment to the door lock / catch assembly. However, periodically check the tightness of the retaining screw to the end of the door handle shaft. (Fig. 7)**

Gently tap the hinge pins in the direction to compensate for the misalignment.

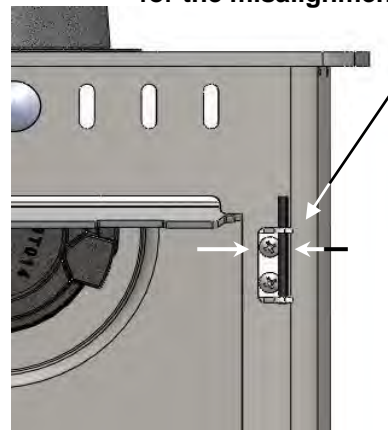

Fig. 6. Adjusting The Door Hinges

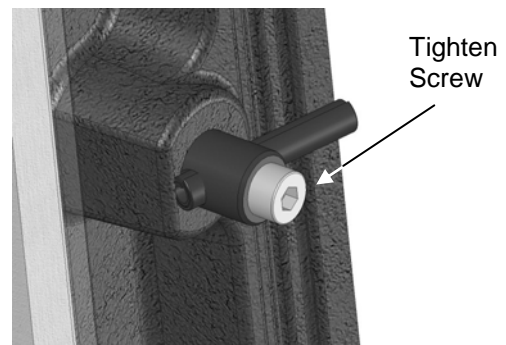

Fig. 7. Retaining Screw Tightness

### FUEL RETAINER BARS—INSPECTION

Fuel retainer bars are supplied with the stove. Periodically check for any bowing or heat distortion to the fuel retaining bars and replace as necessary.

**Please Note : This operation should only be carried out when the appliance is unlit and cold.**

### FIRE DOOR ROPE REPLACEMENT

Periodically, visually check over the fire door rope seal for any damage, cuts or tears and any detached sections. The rope gasket can be replaced, using the universal rope kit (see spare parts guide Page 32), please follow the instructions below :

- Ensure the appliance is cold.
- Lift the door off the appliance and lay onto a flat surface with the rear face upwards.
- Carefully remove the old rope gasket and old adhesive. Take note of the layout of the old rope seal. Ensure no traces of the old adhesive or rust / flaky paint is present, as this will result in a unsound joint.
- Apply the rope adhesive following the instructions on the bottle.
- Press the rope gasket into the channel on the rear of the door casting, following the same layout as the old rope seal. See Fig. 8.
- Just before the final end, cut the rope seal to length and glue into position.
- Allow 30 minutes, before refitting the door to the appliance.

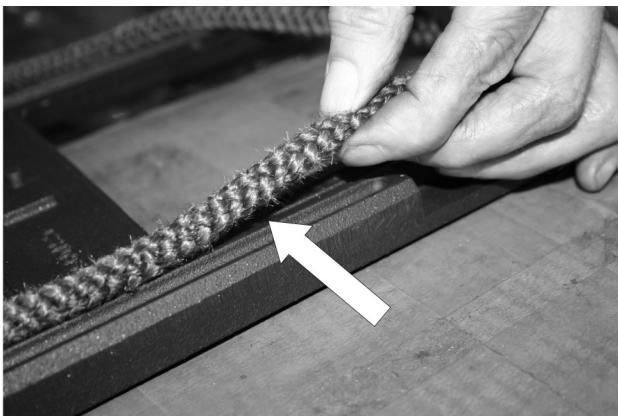
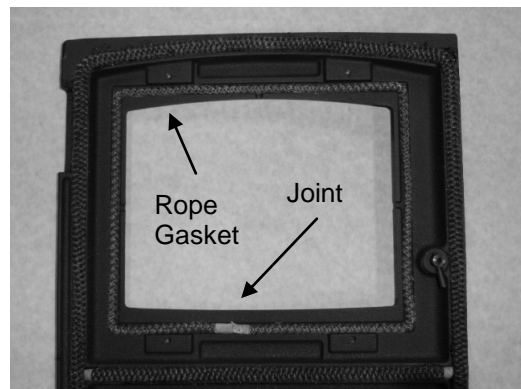

**Fig. 8. Rope Replacement**

### FIRE DOOR GLASS REPLACEMENT

In the event of the door glass being broken it can easily be replaced. Please follow :

- The door should be lifted off the hinges so that the operation can be carried out on a work bench or similar level surface.
- Unscrew the four screw fixings, securing the glass clips and remove, both clips and fixings.
- Carefully remove any pieces of broken glass, and sealing gasket, wearing suitable gloves as protection. Take note of the position and joint of the rope gasket.
- Replace the glass rope gasket; start at the bottom of the window, centrally, push the adhesive side of the rope into the groove on the rear of the casting. Gradually work your way around until the end of the rope meets. See Fig. 9.
- Re-seat the new glass, ensuring the glass sits flat against the gasket. See Fig. 10.
- Replace the four retaining clips and fixing screws. Do not over tighten the fixings as damage may occur to the glass. See Fig.11.
- Refit the door assembly back onto the stove; carefully lift the door over the hinge and slot into place.



**Fig. 9. Lining Up Gasket Rope**

## SERVICE & MAINTENANCE



**Fig. 10. Positioning The Glass**



**Fig. 11. Tightening The Glass Clip**

***Please Note—This should be carried out when the fire is cold and unlit.***

## FIRE DOOR PRIMARY AIR INLET

Once a year inspect the primary air inlet assembly located at the base of the fire door.

- Lift the door assembly from the stove body and place on a level, work bench, with the rear face upper most.
- Remove the 2x no. fixings.
- Working from the front, withdraw the oval assembly from the door casting.
- Clean the air slots within the door casting and slider plate.
- Place the oval assembly into the door oval aperture and fix from the rear of the door. See fig 12

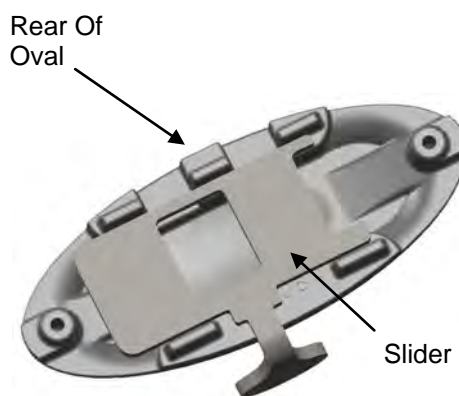

**Fig. 12. Rear Of Oval / Slider Assembly**



# OPERATING INSTRUCTIONS

---

## FUEL TYPES

### SAFETY NOTICE

The most efficient use of this appliance is with the fire door(s) closed at all times, apart from re-fuelling (when alight) or cleaning (when cold).

**NEVER** leave the appliance unattended for an extended length of time with the door(s) open. If this is the case, a spark guard must be used and the operating efficiency of the appliance will decrease.

**WOOD**— Any type of wood is suitable provided it is well seasoned and has a moisture content below 20%. This usually implies that the timber has been suitably stored to allow moisture to evaporate for at least nine months in the case of soft woods, and at least eighteen months in the case of hard wood. We recommend that for general burning, wood should be split into logs of no more than 100mm (4") diameter.

**WARNING** : wet wood must not be used as this will greatly contribute to the creation of tar and creosote which may, in extreme cases, run down the chimney in liquid form. This will seriously damage both the chimney and the appliance, and increase the risk of a chimney fire.

**Please Note** : If you have sticky tar inside the appliance or chimney your wood is 'Green' or too wet.

**Please Note** : The burn classification for all appliances in these instructions are classed as intermittent use.

### Recommended Reading ;

"Wood as a fuel" available from the Forestry Commission.

**PAPER**— Paper will burn successfully. Burn dry paper only or chimney damage will occur.

**WARNING** : NEVER BURN PLASTICS OR HOUSEHOLD WASTE IN YOUR STOVE.

**WARNING** : NEVER BURN LIQUID FUELS IN YOUR STOVE.

**PLEASE CONTACT** : The Manufacturer For Further Details & Advice On The Use Of Other Fuels.

For additional further advise on fuels, please refer to HETAS, Tel 0845 634 5625 or [www.hetas.co.uk](http://www.hetas.co.uk) and or Solid Fuel Association, Tel 0845 601 4406 or [www.solid-fuel.co.uk](http://www.solid-fuel.co.uk)

HETAS Approval only covers the use of wood on the appliance and does not cover the use of other fuels either alone or mixed with other fuels, nor does it cover instructions for uses of other fuels.

**Please Note** : Do not use smaller sizes than Stovesse, eg: Beans, Peas or Grains. Do not use petroleum based solid products such as Calco or Petrocoke. To do so will **INVALIDATE** the appliance Guarantee.

## LIGHTING THE FIRE

**Prior to lighting the stove for the first time, check with the installer that :**

- Installation and all building work is complete.
- The chimney is sound and has been swept and is free from obstruction.
- Adequate provision for combustion air has been made, i.e. a permanent vent of at least 550mm sq per KW of rated output above 5KW, is fitted in the room in which the appliance is installed. Please note page 10, if a flue stabiliser is fitted to the flue.
- That Building Regulations and any local by laws have been followed during installation. See installation section of this manual.
- All firebox liner panels and throat plate are in place.
- That the chimney draw has been checked and is within specification. With the chimney warm, the draught should be between 1-2 mm water gauge or 0.1 to 0.2 mbar.

**WARNING** : An over drawing chimney can cause over firing, resulting in damage to the appliance.

**ENSURE THAT YOU HAVE READ & UNDERSTOOD THESE INSTRUCTIONS BEFORE LIGHTING THE FIRE.**

**ALWAYS WEAR SUITABLE PROTECTIVE FIRE GLOVES WHEN REFUELLING YOUR STOVE.**

## OPERATING INSTRUCTIONS

---

### BURNING WOOD

- Set the fire; by using rolled up newspaper and lay a layer of dry kindling wood on top of this.
- Use 2 or 3 fire lighters to light the kindling.
- Set the primary air and air wash controls to fully open position. See page 26.
- After the kindling has caught light, leave the fire door ajar by about 20mm. This will aid flue draw.
- The flue draw should be established after 5 Minutes, and the kindling well burnt down to form an ember bed.
- Carefully load the stove with well seasoned wood and close the fire door.
- After 10 to 15 minutes, regulate the air wash control, typically reduce to approximately half way.
- Similarly, reduce the primary air control, to the off position (-) as generally no air from below the grate is required when burning wood.

*Please Note : The high temperature paint acquires durability by being "cured" during the initial firings of the appliance. It will give off fumes which are non toxic, but certain persons may find they have an unpleasant or irritant effect. Ensure that the surrounding area is well ventilated during this time.*

### REDUCED BURNING

*Please Note : Classification of these appliances are for intermittent use.*

Lower or reduced burn rates are possible by reducing the primary and secondary (air wash) air inlet controls to a lower setting. Please note if both controls are set on the minimum settings the appliance will be starved of air and die down.

**WARNING** : when wood is burnt slowly in a closed appliance, it produces moisture and tar, which will create condensation and deposits in the chimney. This effect can be minimised by burning hard for a short period, 15 to 20 minutes, twice a day.

*Please Note : To avoid chimney problems your appliance should not be burnt at a reduced burn rate without a period of fast burning.*

**WARNING** : Properly installed, with a suitable flue or chimney, operated and maintained correctly, this appliance will not emit fumes into the dwelling. Occasional fumes when de-ashing and re-fuelling may occur. However, persistent fume emission is potentially dangerous and must be investigated by a HETAS registered installer.

**Stop using the appliance if you smell fumes or see smoke escaping.**

If fume emission does persist, the following immediate actions should be taken :

- Open doors and windows to ventilate room.
- Let the fire die or extinguish and safely dispose of fuel from the appliance.
- Check for flue or chimney blockage, and clean if required.

*Seek expert advice from your HETAS registered installer. Do not attempt to re-light the fire until the cause of the fume emission has been identified and corrected.*

## OPERATING INSTRUCTIONS

---

### OVER FIRING & CHIMNEY FIRES

**DO NOT** over fire your appliance. Using flammable liquids or too much wood or firing the stove at maximum for prolonged periods may result in over-firing. If the chimney connector or casing glows red the appliance is being over-fired this may result in a chimney fire. If this occurs :

- **Call the Fire Service—Dial 999**
- **Immediately close all of the air inlets to the appliance, to reduce the air supply to the stove.**
- **Move items of furniture and combustibles away from the stove, to reduce a risk of fire and to allow access for the fire service.**
- **Ensure access to the loft space is available.**
- **Evacuate the property.**

The chimney fire may cause structural damage to the chimney. Do not use the appliance until the chimney and connector have been inspected and any damaged parts have been repaired or replaced. This should be done by a HETAS registered engineer.

### ASH REMOVAL

The appliance will require ash to be removed periodically but an ash bed of approximately 20mm (3/4") should be maintained. Ash may be removed with a small shovel whilst the fire is still lit by raking the embers of a low fire to one side of the firebox and carefully removing the ash, then repeating the procedure for the other side. Care must be taken not to risk burning of hands or household objects from falling embers.

The ash pan should be emptied at least twice a day or when the level of ash reaches the top of the ash pan. On no account should the ash be allowed to build up to touch the underside of the grate bars, as this will greatly reduce the life span of the grate. When the appliance is burning **WOOD**, it is acceptable to maintain an ash bed on top of the grate bars, of approximately 20mm (3/4") without any un-due effect upon the grate bars.

**WARNING :** The ash can be very hot. Empty only into a metal container. Even if the ash appears cold, red-hot pieces of ash may be concealed and could easily start a fire or cause an injury



## OPERATING INSTRUCTIONS

### AIR INLET CONTROLS

The Aarrow Ecoburn stoves have two air inlet controls.

The primary air inlet providing under draught to the base of the fire chamber through the control slider located under the oval at the base of the fire door.

The air wash system, (secondary air) so called because its pre-heated high speed air, washes across the inner face of the door glass, keeping it clear. This also provides an over draught to the fuel bed.

### PRIMARY AIR

Air enters the appliance through the control on the bottom of the fire door. The Aarrow Ecoburn has a single control knob which slides left to right. Sliding the knob to the right (+), see Fig. 13, will increase the amount of air intake to the stove. To decrease, push the slider to the left (-) as in Fig. 14



Fig. 13. Fully Open Position



Fig. 14. Fully Closed Position

### AIR WASH SYSTEM

The air wash has an internal sliding plate with slots, housed in a cover plate, and is located above the fire door. Sliding the control knob to the **RIGHT** as far as it will go, achieves the fully open position, see Fig. 15. . Sliding it to the **LEFT** will shut off the air inlet slots as shown in Fig. 16.

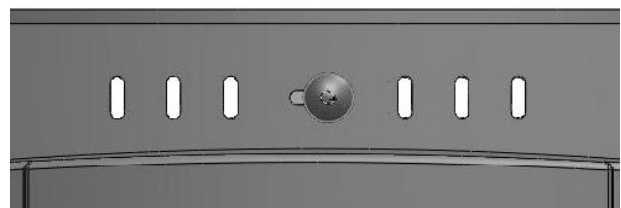

Fig. 15. Air Wash Fully Open Position

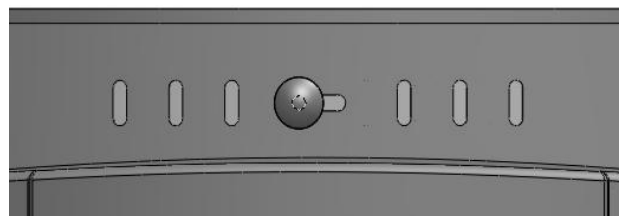

Fig. 16. Air Wash Fully Closed Position

### FUEL RETAINER BARS

Fuel retaining bars are supplied with the stove. For wood burning, the top fuel retaining bar may be removed to afford a better view of the fire. Slide and lift the bar until it is clear of the guides at each side, and remove through the fire door opening. The bars are symmetrical and of even lengths making incorrect fitting impossible.

**Please Note—This should be carried out when the stove is cold and unlit.**

## OPERATING INSTRUCTIONS

---

### MULTI PURPOSE OPERATING TOOL

Your Aarrow EcoBurn stove is supplied with a multi purpose operating tool, used for adjusting the air inlet controls and the removal of the ash pan ( See fig. 17 )

### TO EMPTY THE ASH PAN

The Ecoburn stoves are supplied with a unique ash pan. To empty or remove the ash pan, open the fire door(s), fit the fork end of the operating tool into the ash pan slots and remove from the ash pit chamber.

Empty the ash into a suitable container and replace the ash pan into the stove, withdraw the operating tool and close the fire door(s).

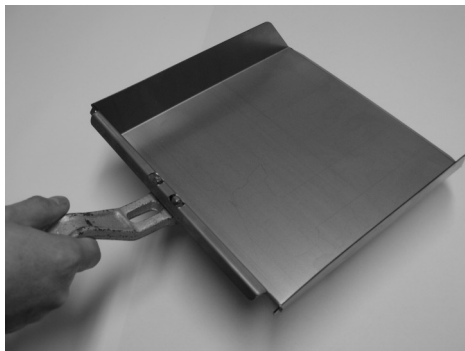

Fig. 17. Operating Tool & Ash pan

### AIR WASH / PRIMARY CONTROL KNOBS

The operating tool can also be used to adjust the air wash control knob. Use the fork end of the tool, place side onto the knob and tap in the desired direction. (See Fig. 18.)

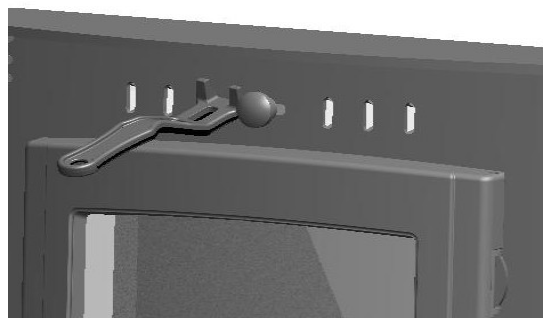

Fig. 18. Adjusting Air Wash Controls

## OPERATING INSTRUCTIONS

---

### MAIN FIRE DOOR HANDLE

A stove mitten is supplied with your Aarrow Ecoburn stove, this is provided for the operation of the fire door handle whilst the stove is in use. Care must be taken when opening and closing the fire door as any surrounding areas of the stove will be very hot.

**WARNING :** Never attempt to open the fire door whilst the appliance is in use WITHOUT the use of the stove mitten or suitable gloves, serious injuries may occur.

Caution must be given when re-fuelling the appliance, always keep the stove mitten away from naked flames and sparks.

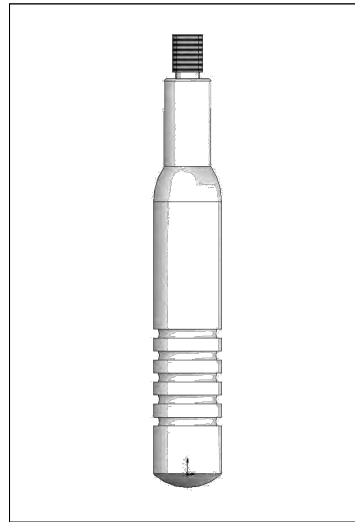





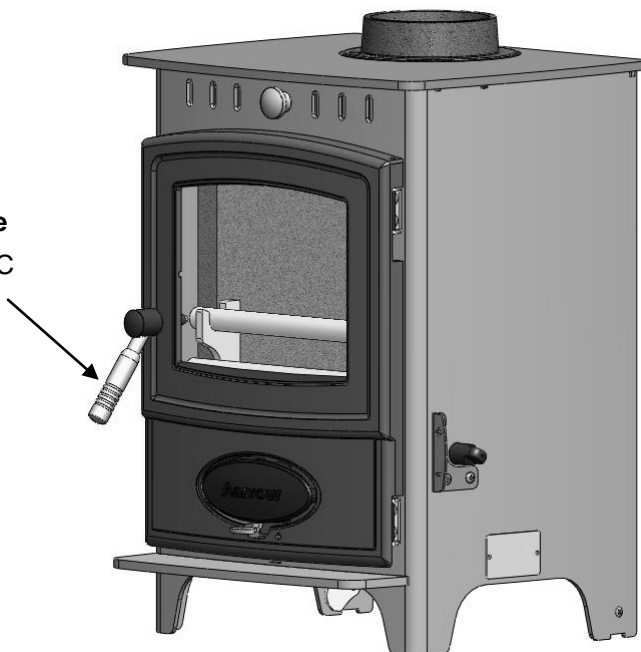

Fire Door Handle (Nickel Plated)

#### The Main Fire Door Handle

This handle can reach 100°C  
Always use a stove mitten

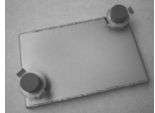

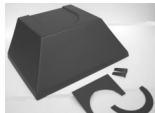
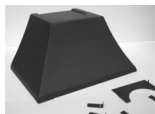
## OPTIONAL EXTRA / ACCESSORIES

PART DESCRIPTION	Visual Aid (not to scale)	Aarrow ECB 5	Aarrow ECB 7	Aarrow ECB 9	Aarrow ECB 11
Aerosol Touch Up Paint		AFS 101a	AFS 101a	AFS 101a	AFS101a
Gothic Door Tracery		ECB 5 TRACE G	ECB 7 TRACE G	ECB 9 TRACE G	ECB 9 TRACE G
Lattice Door Tracery		ECB 5 TRACE L	ECB 7 TRACE L	ECB 9 TRACE L	ECB 9 TRACE L
Add In Slab Boiler ***		AIB 0	AIB 8	AIB 9	AIB 10
Floor Fixing Kit		AFS1135	AFS1135	AFS1135	AFS1135
Stands *		ECB 5 STAND	ECB 7 STAND	ECB 9 STAND	ECB 11 STAND
Add On Low Canopy		AOC XSL	AOC SL	AOC ML	AOC LL
Add On High Canopy		N/A	AOC SH	AOC MH	AOC LH
Convactor Kit**		ECB5 CONKIT	ECB7 CONKIT	ECB9 CONKIT	ECB11 CONKIT
Kooler To Touch Fire Door Handle		AFS1305	AFS1305	AFS1305	AFS1305

**NOTE :**

\* - The overall height of the stand is 160 mm. This increases the combined height of the stove and stand by 100mm. This will effect the height from the floor to the centre of the rear flue outlet, just add 100mm to the stated rear flue outlet, see page 8 for technical information.

\*\* Fitting of the convactor kit, will reduced the distance to combustibile materials, please see bottom table on Page 8.







\*\*\* Separate instructions are included for all add in boiler installations.

## SPARE PARTS LIST

**PLEASE NOTE :** The serial number of your stove can be found stamped into the casing , centrally between the bottom edge of the fire door aperture and the top edge of the ash pit aperture.



PART DESCRIPTION	Visual Aid (not to scale)	Aarrow ECB 5	Aarrow ECB 7	Aarrow ECB 9	Aarrow ECB 11
Throat Plate		AFS1286	AFS1287	AFS1288	AFS1289
Flue Spigot		AFS009A	AFS009	AFS009	AFS011
Hot Plate		AFGS009B	AFS009	AFS009	AFS012
Rear Liner(s)		AFS1207	AFS1210	AFS1213	AFS1244
Side Liners		AFS1206	AFS1209	AFS1212	AFS1243
Liner Set		AFS1205	AFS1208	AFS1211	AFS1242
Ash Pan		AFS058	AFS051	AFS1309	AFS0052a
Fuel Retainer		AFS1190	AFS1192	AFS1191	AFS1240

## SPARE PARTS LIST

PART DESCRIPTION	Visual Aid (not to scale)	Aarrow ECB5	Aarrow ECB7	Aarrow ECB9	Aarrow ECB11
Operating Tool		AFS008	AFS008	AFS008	AFS008
Replacement Glass Kit		AFS1214	AFS1215	AFS1216	AFS1216
Replacement Glass Rope Gasket & Clips (Universal Length)		AFS1365	AFS1365	AFS1365	AFS1365
Hinge & Fixing Kit		AFS047	AFS047	AFS047	AFS047
Fire Door Rope Kit Complete With Glue		AFS1021	AFS1021	AFS1021	AFS1021
Fire Door Assembly, Complete		AFS1218	AFS1219	AFS1220	AFS1220
Fire Door Handle Assembly		AFS1306	AFS1306	AFS1306	AFS1306
Replacement Instructions		AFS1363	AFS1363	AFS1363	AFS1363

## SPARE PARTS LIST

---

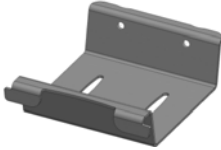
PART DESCRIPTION	Visual Aid (not to scale)	Aarrow ECB5	Aarrow ECB7	Aarrow ECB9	Aarrow ECB11
Replacement Stove Mitten ( <b>Hot Glove</b> )		AFS1285	AFS1285	AFS1285	AFS1285
Replacement Primary Air Inlet Slider		AFS1368	AFS1369	AFS1369	AFS1369
Replacement Air wash knob		AFS1405	AFS1405	AFS1405	AFS1405
Wood Burning Tray		AFS 1196	AFS 1197	AFS 1198	AFS 1483

## GUARANTEE

---

### **Guarantee**

Once again we would like to thank you for buying an Arrow Ecoburn stove.

When you buy an **Arrow** stove, you are not only buying a first class appliance you are buying a commitment from us to look after you and your appliance for as long as you want.

Your Ecoburn stove comes with a **LIFETIME GUARANTEE** against splitting or cracking of the main body. The main body being defined as the steel outer casing and items fixed immovably to the casing. All other parts are covered by a one year no-quibble parts guarantee.

This guarantee shall not apply to any part that has been altered in any way, or which in our judgment has been subjected to misuse, neglect, accident, abuse and fair wear and tear.

Items which would be subject to fair wear or tear, firebox liner panels, fuel retainers, throat plate, door rope, door glass, grate or grate bars and gaskets are not covered by the guarantee. However, should you have any problems with your appliance, please contact your Arrow stockist who will have the knowledge and facilities to help you.

**Arrow (Arada Ltd)**, cannot guarantee items which are susceptible to breakage or damage through careless handling, dropping etc., or through misuse of the appliance by over firing, burning petroleum coke, etc. Nor can the guarantee be extend to deterioration of parts through fair wear and tear. Firebox linings, grate bars, fuel retainer, baffle, gasket materials and door glass are therefore not covered by the guarantee.

The guarantee is conditional upon the appliance being serviced and checked annually by a qualified heating engineer, with documentation to be retained and produced in the event of a claim being made.

**Claims are not valid where installation does not conform to appropriate building regulations.**

The manufactures decision shall be final.

**If your appliance proves to be defective as a result of faulty materials or workmanship during the guarantee period, we will repair or replace it FREE OF CHARGE as long as the stove has been installed according to this manuals instructions and the Final Installation Check List on page 17 has been completed and signed by a suitably qualified engineer at the time of installation.**

**USE OR SPARE PARTS OTHER THAN THOSE SUPPLIED BY AARROW WILL INVALIDATE THE APPLIANCE WARRANTY.**

**AARROW WILL NOT BE RESPONSIBLE FOR ANY CONSEQUENTIAL OR INCIDENTAL LOSS, DAMAGE OR INJURY HOWEVER CAUSED.**

All guarantee periods commence on the date of purchase and are non-transferable.

Our guarantee is offered as an addition to your statutory rights.

If you think your stove is not working correctly or in the event of a breakdown , **Please call your local dealer.**

When you call your dealer they will want to know:

1. Your Name, Address, post code and telephone number.
2. Your stove's serial number.
3. Clear and concise details of the fault.

This installation and operating manual gives sufficient details to enable the appliance to be installed and maintained. If further information is required, our technical helpline will be pleased to help.

Please telephone **0844 8475107** or email: **info@arada.uk.com**

### **Please Note:**

**The appliance serial number can be found stamped into the casing of the main stove body, centrally just below the bottom edge of the fire box aperture.**





## *Lifetime Guarantee*

*For your peace of mind*

Arrow stoves gives a Lifetime Guarantee against manufacturing defects of the main body\* Of its Ecoburn range of stoves. Additionally, all other parts are covered by a one year no quibble replacement guarantee. This guarantee covers replacement of the item only and does not extend to any other costs, including labour, incurred in its replacement. Documentation must be retained and produced in the event of a warranty claim. This guarantee specifically does not cover accidental damage, misuse, wear & tear. The use of non Arrow replacement parts will invalidate your warranty. For full details, contact your local Arrow retailer. All guarantees are in addition to your statutory rights. Please see page 32 for further information regarding the lifetime guarantee.

\* The main body defined as the steel outer casing and items fixed immovably on to its casing.

**Final Factory Check list**

Stove Model .....
Serial No. ....



Quality / Finish	
Parts	
Wood Tray	
Flue Outlet	
Hot Plate	
Fuel Retainers x 2	
Firebox Liners	
Throat Plate	
Door Catch/Nickel Door Handle	
Convactor Kit Fixings x 4	
Ash Pan	
Adjusting Feet x 2	
Operating Tool	
Operating & Installation Manual	
Stove Mitten	

***I've checked it  
and its O.K !***

Assembled By.....

Checked by.....

Date of Purchase.....

Name and Address of Supplier.....

.....  
.....

**Arada Ltd  
The Fire Works  
Millway Industrial Estate  
Axminster  
Devon  
EX13 5HU  
United Kingdom**

**Tel: +44(0)1297 35596 Fax: +44(0)1297 35900 www.arada.uk.com**