



## Operating & Installation Manual

---

# Acorn Multifuel Stoves



The Acorn 4 Multifuel Stove (shown above)

PLEASE RETAIN THESE INSTRUCTIONS FOR FUTURE REFERENCE

---

Arrow Fires Ltd  
The Fireworks  
Bridport  
Dorset, DT6 3BE  
Great Britain

Tel. (44) 01308 427234  
Fax. (44) 01308 423441  
[www.arrowfires.com](http://www.arrowfires.com)

Rev 2  
Part No: AFS1126  
March 2004

---

*Congratulations on your choice of an Aarrow Stove.*

*More than 20 years experience has been put into the development of our Acorn Multifuel to ensure ultimate performance and years of trouble free enjoyment.*

*Every detail on the fire has been carefully engineered and designed which is why we are so confident in the reliability of our product that we offer a 3 year guarantee.*

*Should you have any questions about our Acorn Stoves that are not covered in this manual, please contact the Aarrow dealer in your area, or call our Technical support department on  
01308 427234*

**© COPYRIGHT 2004**

Aarrow Fires Ltd

This booklet has copyright & may not be copied in whole or part or be used for any purpose other than that for which it is supplied without express written consent from Aarrow Fires Ltd.

---

## CONTENTS

---

<b>INTRODUCTION</b>	<b>Page</b>	<b>OPERATING INSTRUCTIONS</b>	<b>Page</b>
Safety Notices	5	AirInlet Controls	16-17
The Principle of the Fire	5	Airwash System	16-17
Check List	6	Multi-Purpose Operating Tool	17
Technical Data	7	Fire Door Glass	17-18
<b>INSTALLATION</b>	<b>Page</b>	Adjusting the Door Hinges	18
General Precautions	8	Fuel Types	18-19
Handling	8	Lighting the Fire	19
Hearth	8	Extended Burning	19-20
Combustible Materials	8	De-Ashing	20
Air For Combustion	8	Over-Firing	20
Firebox Liner Panels	9	Cleaning & Annual Maintenance	21
Removal of the Throat Plate	9	Final Check List	22
Fitting the Optional Floor Fixing Kit	9	Parts List	23-25
Assembling the Multifuel Grate	10	<b>GUARANTEE</b>	
Flues & Chimneys	11-14	Guarantee	26
Add in Boilers	15-16	Customer Registration	26
		<b>SERVICE RECORD</b>	
		Service Record	27
		Final Factory Check List	28

---

**WARNING**

TO ALL MULTIFUEL USERS

**PETROLEUM COKE**

SOME OF WHOSE BRAND NAMES ARE

**"CALCO", "PETROCOKE" OR "WONDERCO"**

MUST NOT BE BURNED IN THIS APPLIANCE

TO USE THESE FUELS WILL INVALIDATE THE  
APPLIANCE GUARANTEE

**IF IN DOUBT CONTACT THE SOLID FUEL ASSOCIATION  
TELEPHONE NUMBER 0800 600 000**

[www.solidfuel.co.uk](http://www.solidfuel.co.uk)

**THE USE OF SPARE PARTS OTHER THAN THOSE SUPPLIED  
BY AARROW FIRES LTD WILL INVALIDATE THE  
APPLIANCE GUARANTEE.**

### SAFETY

A fireguard conforming to BS 8423: 2002 should be used in the presence of children and old/or infirm people. If the appliance is used with the fire door open, a spark guard conforming to BS 3248 should be fitted.

**Do not use aerosol sprays or any other flame near the appliance under fire.**

**Do not fit an extractor fan in the same room as the appliance.**

**Fire cement is caustic, hand and eye protection should always be worn, prolonged contact with the skin should be avoided.**

**Aarrow Fires Ltd will not be responsible for any consequential or incidental loss or injury however caused.**

Before continuing any further with the installation of this appliance please read the following guide to manual handling.

- Always obtain assistance when lifting the appliance.
- When lifting always keep your back straight. Bend your legs not your back.
- Avoid twisting at the waist. It is better to reposition your feet.
- Avoid upper body/top heavy bending. Do not lean forwards or sideways when handling the fire.
- Always grip with the palms of your hands. Do not use fingertips for support.
- Always keep the stove as close to the body as possible. This will minimise the cantilever action.
- Use gloves to provide additional grip.

---

### THE PRINCIPLE OF THE FIRE

Your Aarrow Fire is built to the highest standard of craftsmanship using the best materials and the most modern equipment available. It is a highly efficient and sophisticated piece of machinery and when properly installed and operated it should provide a lifetime of heating satisfaction.

**Safety** is the most important consideration when installing your fire. If not properly installed and operated a house fire may result. Installation must comply with the Building Regulations and conform to all relevant fire safety standards.

Aarrow Fires produce a variety of appliances ranging from units, which are traditional in style to stoves which are modern in appearance, all bristling with "High Tech" features.

Model types include simple room heaters, convectors, integral boiler models and inset units. Your Aarrow Fire is constructed from either single or twin wall steel strengthened where necessary. Cast iron is used where appropriate for decorative features.

All fire doors are fitted with special high temperature ceramic glass panels through which the fire can be viewed.

Multifuel stoves are fitted with a cast iron grate to give full multifuel facility and positive de-ashing.

All models except integral boiler models are lined with firebricks or heat reflective panels which ensure complete combustion and provide a good heat store to even out fluctuations in burning.

An internal throat plate produces turbulence to encourage secondary combustion and directs the flue gas around the whole upper firebox before allowing it to escape up the chimney.

On multifuel appliances the primary air for burning enters the ash pit chamber beneath the grate, controlled by the air inlet mechanism.











Aarrow Fires are also fitted with an "air wash" so called because it provides a curtain of high speed preheated air behind the glass to help keep it clean and to provide secondary air/over draught.

The provision of two inlets on all multifuel stoves gives a wide range of primary air/secondary air, under draught/over draught combinations.

The optimum settings will only be established by experience in firing the appliance, and will depend on type of fuel, the position of the appliance in the house, condition of chimney etc.

## CHECK LIST

Inside the appliance you should find the following:

Part Description & Visual Aid (not to scale)	Acorn 4 Multifuel		Acorn 5 Multifuel	
	Quantity	Part No.	Quantity	Part No.
1. Grate bars 	5	AFS001	5	AFS001
2. Integral front brace/retainer 	1	AFS1101	1	AFS1101
3. Throat plate 	1	AFS1086	1	AFS1018
4. Flue spigot 	1(4")	AFS009A	1(4")	AFS009A
5. Hot plate 	1(4")	AFS064	1(4")	AFS064
6. Ash pan 	1	AFS1141	1	AFS1141
7. Operating tool 	1	AFS008	1	AFS008
8. Rear liners 	1	AFS1094	1	AFS1059
9. Side liners 	2	AFS1092	2	AFS1058
10. Fire door handle 	1	AFS205	1	AFS205
11. Instructions	1	AFS1126	1	AFS1126

**The model and Serial Number of your fire can be found stamped into the casing, centrally just below the bottom edge of the fire door aperture.**

## TECHNICAL DATA

---

<b>TECHNICAL DATA</b>	<b>Acorn 4 Multifuel</b>	<b>Acorn 5 Multifuel</b>
Room Min/Max Room Heater Only Output (kW)	1- 4.5	1 - 5
Room Heater with Domestic Hot Water with add in boiler <b>type</b>	Type 7	Type 0
Max Output to Room (kW)	3	3
Max Output to Water (kW)	1.5	2
Height (mm)	458	483
Width (mm)	355	395
Depth (mm)	350	350
Height to Centre of Rear Flue	360	387.5
Depth from Back to Centre of Flue	90	96
Flue Diameter (mm)	102 (4")	102 (4")
Weight Unpacked Packed	43 Kg 46 Kg	44 Kg 47 Kg

# INSTALLATION

---

## GENERAL PRECAUTIONS

*Note - All installations must conform to the appropriate building regulations.*

The Building Regulations for England and Wales 2000 ref Approved Document J 2002 edition (issued by the DTLR).

The Building Standards (Scotland) (Consolidation) Regulations.

Detailed recommendations for installation of appliances, chimneys and flues are outlined in the current issue of the following British Standards:- BS6461, BS8303 and BS4543.

*Any Manufacturer's Instructions must not be taken as overriding statutory requirements.*

During installation ensure that adequate precautions are taken to avoid unnecessary risk to yourself or any householder. In particular the danger from the caustic nature of the fire cement should be avoided by using these accepted methods:

- Wear gloves when handling fire cement.
- Wear goggles when chiselling or looking up chimneys.

Make sure that Building Regulations are adhered to during installation along with any local by-laws. In the case of heating systems make sure that the pipe work is correctly bonded to ensure electrical earthing.

## HANDLING

By the time you read this you will appreciate the weight of the appliance. The Safety and handling guidelines as set out on page 5 of this manual should be followed.

To make movement easier internal fittings, grates, firebox liners, flue outlets, hot plate, throat plate, etc., can be removed.

Care should be taken to make sure that the hinges are not damaged during installation.

## HEARTH

The fire should be installed to stand on a constructional hearth of non-combustible materials not less than 125mm (5") thick conforming to Building Regulations. Dimensions of the hearth should project at least 300mm (12") forward of the front of the appliance and 150mm (6") at the sides. The surface of the hearth should be free of combustible materials. In most buildings with solid concrete floors the requirement will be met by the floor itself, but mark the perimeter of the hearth to ensure floor coverings are kept well away or use different levels to mark the hearth perimeter.

## COMBUSTIBLE MATERIALS

A gap of at least 450mm (18") should be allowed between the appliance and any combustible materials including furnishings. Adjacent walls should be of suitable non-combustible construction, preferably brickwork. In large fireplaces take care that any supporting beam is protected by a 13mm (0.5") sheet of Masterboard/Supalux spaced 13mm (0.5") off the surface with strips of non-combustible material - not wood.

Make sure that there is a gap between an uninsulated flue system and any combustible material. This gap must be at least 3 x the outside diameter of the flue pipe, or 1.5 x the flue diameter to non combustible surfaces. See the illustration on page 14.

## AIR FOR COMBUSTION

There must always be a permanent means of providing air for combustion into the room in which the fire is installed. A permanent vent with a total free area of at least 550mm<sup>2</sup> for every kW rated output above 5kw should be connected directly to the outside air or to an adjacent room which itself has a permanent vent of the same size direct to the outside air. The fitting of an extractor fan to either of these rooms is not recommended.



## FIREBOX LINER PANELS

The Acorn Multifuel stoves have reflective liners to the sides and back. The throat plate sits on top of the side and rear panels. These should come fitted to your fire, if however they are not proceed as follows to fit them.

- Remove the front brace retainer.
- Set the small liner into the back of the fire.
- Insert side liner panels
- Fit the throat plate with the single bend and two cut outs to the front facing up. The projecting lugs sit on top of the side liners. The long centre tab on the back edge rests on the rear liners. The shorter turn-down tabs against the vertical face.
- Replace the front brace retainer.

**Note:** *Neither the rear firebox liners nor the side firebox liners are "handed", both faces are suitable for direct contact with the fire.*



**Fig. 1** *Liners inserted in Acorn*



**Fig. 2** *Inserting throat plate*



**Fig. 3** *Liners, throat plate and grate in the Acorn.*

## REMOVAL OF THE THROAT PLATE

Blocked chimneys cause dangerous fumes to escape. Remove the throat plate at least monthly to clean. Keep chimney and flue ways clear.

## FITTING THE OPTIONAL FLOOR FIXING KIT

Once the stove is in the correct position it is recommended that the fire is fixed to the floor for safety purposes:

You will need a No. 2 pozi drive screw driver to carry out this operation. Place the brackets each side of the appliance.



**Fig. 4** *Lining up the bracket*

Slide the small threaded hole underneath the gap (as shown above) and turn inside so the both holes match the pre-drilled one. Repeat for the other side.



**Fig. 5** *Inserting and tightening the screws.*

When both are in place, tighten the screws until they are firmly inserted.

Then proceed to drill your hearth and insert and anchor bolt or similar fixing (Not supplied in kit) and bolt down the brackets once the appliance is in place. For further instructions please consult the floor fixing instructions attached to the kit.

# INSTALLATION

---

## MULTIFUEL GRATE

### GRATE

The grates in the Acorn Multifuel units comprise a series of reciprocating cast iron bars seated on a pivoted "comb". All bars in the grate are identical, but every other bar is turned through 180 degrees, with the ends of the bars marked "H" sitting on the high sections of the comb, and the ends marked "L" sitting on the low sections.

### ASSEMBLING THE GRATE

To assemble the grate, fit bars to low sections of the comb first, inserting end marked "H" into rear channel with groove on underside of bar located on upstand tab, and then lowering end marked "L" onto the low section of the comb. The upper bar is fitted in a similar manner, but with the end marked "L" inserted in the rear channel, and the end marked "H" seated on the high section of the comb.

### GRATE BAR REPLACEMENT

After extended use it may be necessary to replace some of the grate bars.

Periodic inspection of the bars is recommended and the removal of any nails or wire that may be present after burning wood. All the grate bars in each appliance are identical and can easily be lifted out after removal of the fuel retainers. Remove damaged grate bars and replace with casting of the same type, fitting as per instructions above. (Check Identification letters on the casting when reordering).

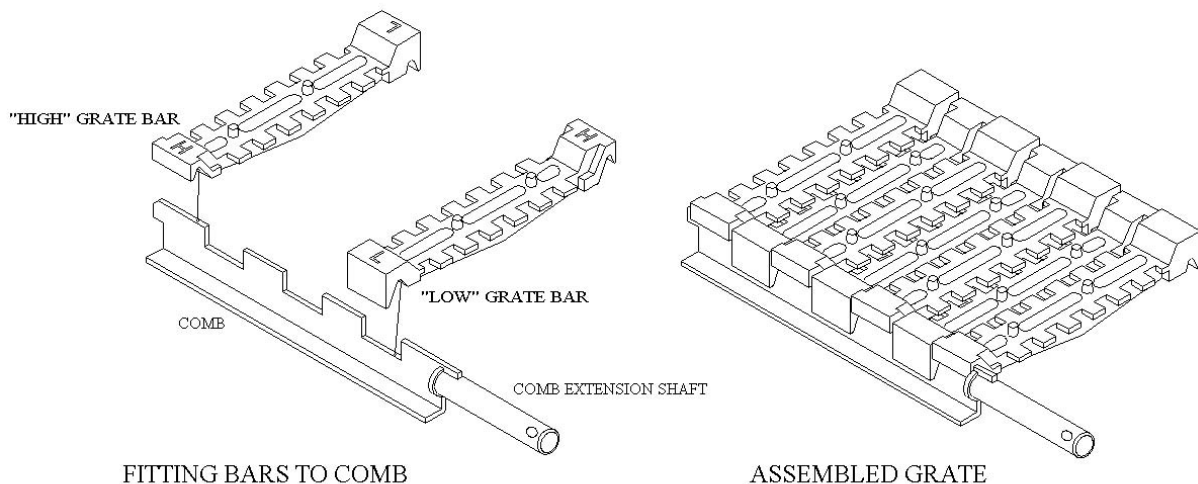

## FITTING THE FLUE OUTLET AND HOT PLATE

The flue outlet spigot is found inside the appliance. It is removed by turning clockwise.

Smear a very thin layer of fire cement on the faces of the flue outlet and the blanking plate. Fit the outlet to the appliance in the desired position.

Lock into place by rotating anti-clockwise and tighten by tapping with a block of wood and mallet from the inside of the appliance. Similarly, fit the blanking plate to the unused opening. Clean off any surplus fire cement.

Place appliance on the hearth and make sure that it is level and does not rock. Connect the chimney ensuring all joints are sealed with fire cement.

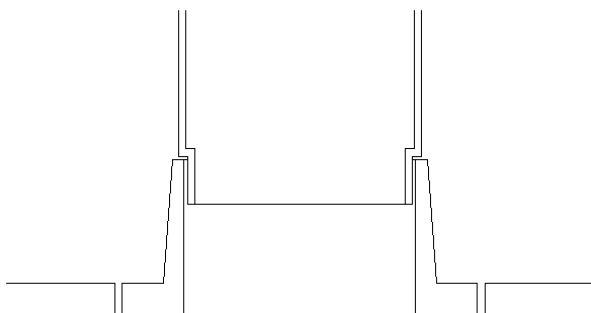

\*NOTE  
THE FLUE PIPE MUST BE FITTED INSIDE THE OUTLET SPIGOT  
FAILURE TO DO SO COULD RESULT IN THE SPILLAGE OF  
CONDENSATION ETC. RUNNING DOWN THE FLUE.

**Fig. 6 Flue and Spigot Fitting**

## FLUES AND CHIMNEYS

Please remember that chimney draught is dependent on four main factors:

- Flue gas temperature.
- Flue height.
- Flue size.
- Flue terminal.

The stove must be connected to a suitable and efficient flue that provides a good up draught to safely take the products of combustion (fumes) from the stove outlet to the outside air. To ensure a good updraught it is important that the flue gases are kept warm and that the flue size suits the stove.

The termination of the outlet at the top of the flue also needs to comply with the Building Regulations. The minimum effective height of the flue must be at least 4.5 metres from the top of the stove to the top of the flue outlet. When warm the flue draught should be between 0.1 and 0.2 mb.

A chimney may comply with the regulations but still be subject to down draught and similar problems. A chimney terminating above the ridge level is generally less likely to suffer such problems.

If a new chimney is being provided it should fully comply with the relevant Building Regulations that specify the requirements for solid fuel burning installations. Suitable types of chimney include the following.

**Masonry chimney** built with clay or concrete liners, or a chimney block system meeting Building Regulations. These types of chimney should be installed in accordance with the Building Regulations and BS 6461: Part 1. See page 12 for a typical installation diagram.

**Factory made insulated chimney** complying with BS 4543: Part 2 (often called "Class 1 prefabricated metal chimney"). These types of chimney should be installed in accordance with the Building Regulations and BS 7566: Parts 1 to 4. See page 12 for a typical installation diagram.

## INSTALLATION

---

Due to the gradual introduction of European Chimney Standards chimneys will be specified according to their performance designation as defined in BS EN 1443 that covers the General Requirements for chimneys. The minimum performance designation required for use with solid fuel burning stoves is T450 N2 S D3.

The flue and chimney installation must be carefully checked by a competent person before fitting the stove to ensure it is suitable and will work safely.

If the chimney is old (ie built of brick or stone without a liner) or being opened up for reuse additional checks and smoke testing as described in Appendix E of the Approved Document J 2002 Edition should also be carried out to ensure the flue and chimney are in good operating condition.

Unless the existing flue is in good condition with suitable access for collection and removal of debris. If the flue size is more than 225mm (9 inches) diameter or 200 x 200mm square, a suitable lining of 150mm (6 inches) diameter should be fitted, or if the flue length is over 5.5 metres one size larger than the appliance outlet should be fitted. This should be a double skin stainless steel flexible flue liner that is independently certified for use with solid fuel. Details of suitable linings for use with solid fuel are given in the Official HETAS guide that can be viewed on their website at [www.hetas.co.uk](http://www.hetas.co.uk)

It is also important that suitable flue pipe complying with the Building Regulations is used to connect the stove to the flue in the chimney and that suitable access is provided into the flue for regular inspection and sweeping of the flueways.

The installer should comply with the Building Regulation requirements in respect of providing a Notice Plate giving details on the chimney, flue lining, hearth and fireplace installation. Approved Document J of the Building Regulations for England and Wales is available from The Stationery Bookshops and can also be viewed at the ODPM website at:

[www.safety.odpm.gov.uk/bregs/brads.htm](http://www.safety.odpm.gov.uk/bregs/brads.htm)

Details on the relevant Building Regulations and BS British Standards are given in the "General

Precautions" section page 8 of these instructions.

Chimneys should be as straight as possible. Horizontal runs should be avoided except where the rear outlet of the appliance is used, in which case the horizontal section should not exceed 150mm (6") in length.

If the fire appears to be working hard but produces very little output to the room it is likely that excessive draw is present in the chimney, and that heat is being sucked out of the appliance and up the chimney. If this is the case we recommend the fitting of a draught stabiliser in preference to a flue damper, in the interest of safety and efficiency.

We do not recommend the use of a damper when burning solid fuel.

### FOR ALL APPLIANCES

Access for cleaning the flue should be incorporated in the system other than through the appliance (e.g. a soot door or access through register plate). Purpose-made soot doors and inspection lengths are available from manufacturers of all systems.

Ensure that the whole length of the flue can be reached from the soot door.

*Note: if the appliance is fitted with a draught stabiliser or if one is fitted to the flue pipe or chimney in the same room as the appliance, then the permanent air entry opening (or openings) should be increased by 300mm<sup>2</sup> for each kW of rated output.*

**For advice on flues and chimneys contact;  
NACE (National Association of Chimney Engineer): telephone 0800 0924019  
[www.nace.org.uk](http://www.nace.org.uk)**

or

**NACS (National Association of Chimney Sweeps): telephone 01785 811732  
[www.chimneyworks.co.uk](http://www.chimneyworks.co.uk)**

TYPICAL REAR FLUE OUTLET

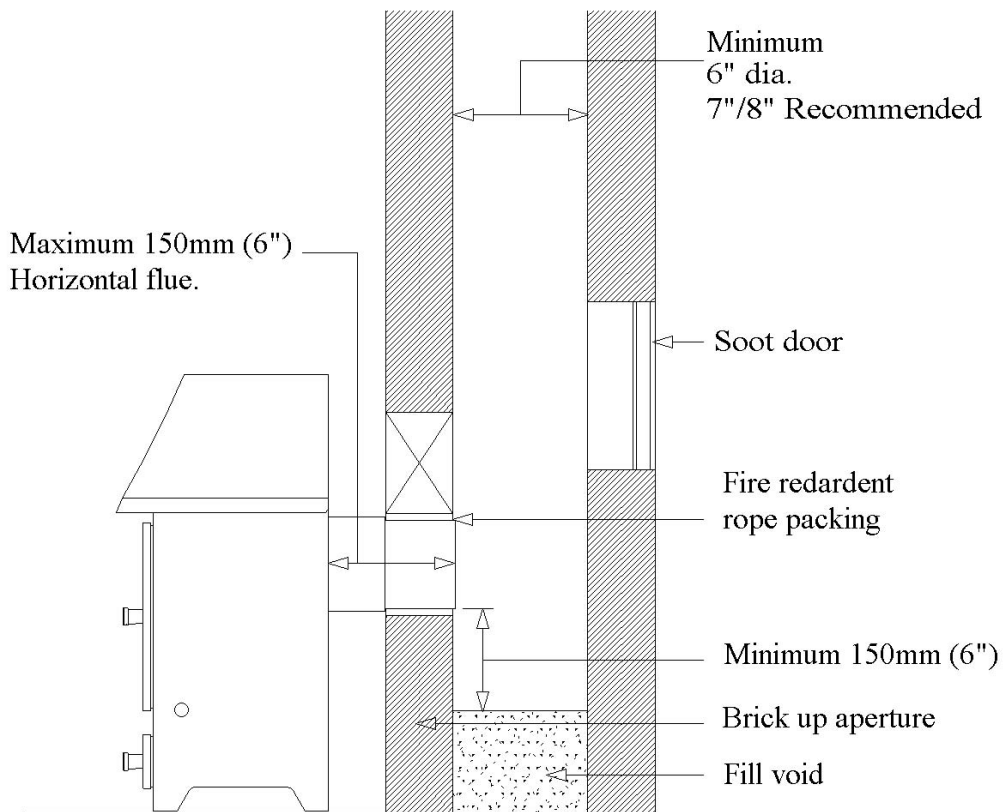

REAR FLUE OUTLET

# INSTALLATION

## TYPICAL METAL INSULATED CHIMNEY SYSTEM

TO BE INSTALLED TO THE CHIMNEY MANUFACTURERS INSTRUCTIONS IN COMPLIANCE WITH BUILDING REGULATIONS AND BS7566 Pts 1-4

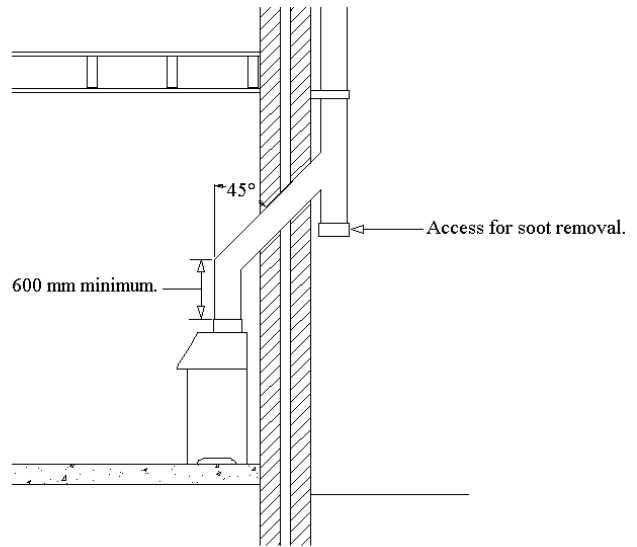
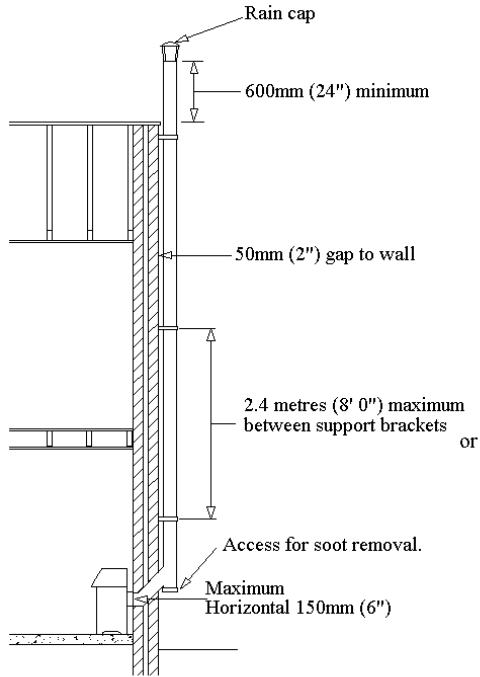

### PLAN VIEW OF REGISTER PLATE AND CLEARANCES FOR NON INSULATED FLUES

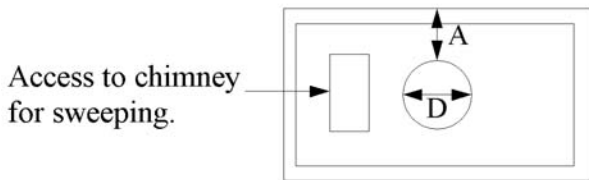

A is minimum clearance for non-insulated flue =

- 1.5 x D to a non-combustible surface/material
- or
- 3 x D to combustible surface/material

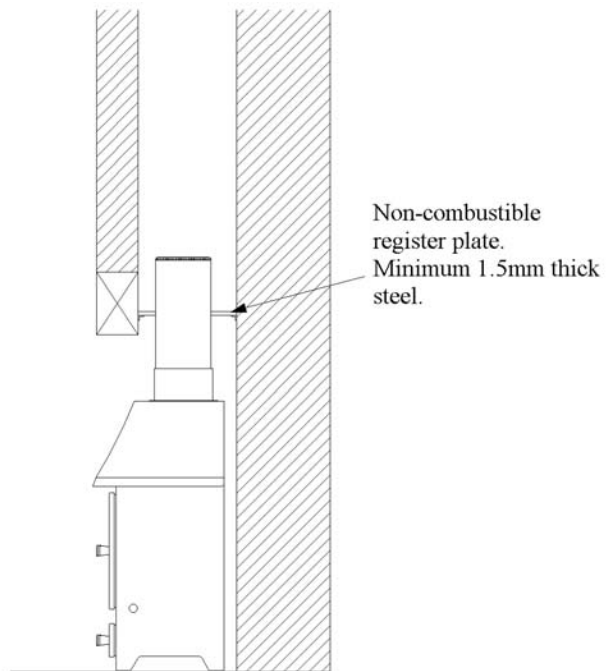

### TOP FLUE OUTLET

### ADD IN BOILERS

Acorn 4 & 5 multifuel stoves offer the option of a slab boiler, which occupies the position of the rear firebox liner panels.

#### Fitting:

- Remove the fuel retainers, rear firebox liner panels and throat plate.
- Knock out the blanking discs in the back plate corresponding to the terminals on the boiler.
- Introduce the boiler to the appliance through the main fire door and locate the terminal pipes through the back plate holes and seal around boiler terminals with fire cement.
- Engage locking nuts to the thread of the terminals and tighten to secure the boiler in position, ready for connection to flow and return pipes.
- Replace throat plate (slab boilers only) and fuel retainers.

*Do not fit a throat plate with a cantilever boiler.*

*Note: On boilers the terminal which is approximately flush with the edge of the boiler must be fitted uppermost, to prevent "Kettling".*

### WATER CONNECTIONS

#### Heating systems

The size of the heating system which can be run, will depend on the output rating of the appliance.

It will be necessary to work out heat loss calculations for the system proposed in order to establish the kW/hr rating. An appliance that will meet this figure can then be chosen; (for boiler outputs please refer to the brochure).

The constructional requirements of installing and connecting the appliance also need to be taken into account when selecting. Design and calculations for individual heating systems should be carried out by a qualified heating engineer. In many cases your supplier will be able to offer advice and assistance.

#### Direct Systems

Stainless steel boilers, either factory fitted or retro-fitted as add-in boilers enable connection to direct systems to be made without the need to change the cylinder or to fit an expansion tank. This applies to domestic water supply only **and should**

**not be done when in an area with soft water.** If radiators are used then an indirect system must be utilised.

To connect the cylinder use 28mm copper pipes. Ensure that the pipes rise continuously to the cylinder.

Ensure that the runs are not too long, i.e. 20ft maximum each for flow and return. Install the cylinder above the level of the fire, and as close to it as possible. (the higher the cylinder the faster the circulation). Ensure that no valves are present in the circulating pipes.

#### Indirect Systems- The Domestic Hot Water Circuit

In addition to providing hot water the primary circuit is essential in providing a "heat leak" to absorb excessive heat produced in the event of the circulation pump shutting down.

Heat is produced in varying quantities while the fire is alight and care must be taken to ensure that effective circulation can occur around the primary circuit to carry heat away and thus stop boiling. The output of any radiator installed as a "heat leak" should not be less than 10% of the rated output of the appliance. The radiator should **not** be fitted with a control valve.

The cylinder must be of the indirect type with a minimum capacity of 110 litres, conforming to BS 1566 part 1.

Primary flow and return pipes should be 28mm diameter. The cylinder should be installed at a higher level than the appliance, and as close to it as possible (the higher the cylinder the faster the circulation). The flow and return pipes should not be longer than 20ft each. Pipe runs should rise continually from the boiler to the cylinder.

A radiator of approximately 25 sq.ft. should be connected into the primary circuit, if installed in the bathroom it provides a means of drying towels in the summer.

#### Safety Vent Circuit

This circuit consists of a cold feed pipe, expansion pipe, and expansion tank. The possibility that water may boil can never be completely ruled out, and it is therefore vital to ensure that cold water can be supplied to the boiler and steam vented from it at all times.

# INSTALLATION INSTRUCTIONS

---

The expansion tank should have a capacity of at least 7 % of the system's water capacity. The cold water feed pipe should be at least 22mm diameter.

There must not be any shut off valves in the circuit. Pipes should be run to avoid air locks. A spring safety valve should be fitted to the expansion pipe close to the boiler.

It is often possible, and is good practice, to utilise the primary flow and return as part of the safety circuit. The ball valve should have a copper ball. The overflow pipe from the expansion tank should be 28mm diameter copper. Pipes in unheated spaces must be lagged.

## FINAL CHECK

Before handing over the installation to the customer it is strongly recommended that the appliance is lit and the functioning of the chimney, hot water and heating system is checked.

A checklist (Pre-lighting Checks) appears in the Operating Instructions, but in addition to this the installer should:

- **Operate the heating system and set the pump head.**
- **Balance the radiators.**
- **Re-vent and ensure no air locks.**
- **Check the circulation round the primary system and the heat leak radiator, particularly when the pump is running, to ensure circulation is not reversed.**
- **Be sure that the chimney is operating and that ALL smoke and fumes are vented to the atmosphere through the chimney terminal.**
- **Check all joints and seals.**
- **Clean the outside of the appliance to prevent any stains becoming burnt on.**
- **Check the flue draught which should read 1 - 2mm, or 0.1 - 0.2mbar.**

The following details **must** be checked and completed in full by the installer at the time of installation. Please answer all questions as fully as possible. **Aarrow Fires Ltd** can not be held responsible for chimney or installation.

<b>HOT WATER SYSTEMS</b>	
Is the boiler cross-flowed?	YES / NO
Are the pipes correctly sized?	YES / NO
What is the calculated output required to heat the system?	
Is a heat leak fitted?	YES / NO
What is the return water temperature?	
Is the pump thermostatically controlled by a pipe stat?	YES / NO
What is the height and distance of the hot water tank above the stove?	

## AIR INLET CONTROLS

The Acorn multifuel stoves have two air inlets:

- The air wash system (so called because its pre-heated high speed air washes across the inner face of the door glass, keeping it clear), which provides over draught, and
- The oval cover; the primary air inlet providing under draught to the base of the fire chamber through control on the bottom of the stove door.

## PRIMARY AIR FOR MULTIFUEL

Air enters the appliance through the control on the bottom of the fire door. The Aarrow Acorn has a single control knob which slides left to right. Sliding the knob to the right will increase the amount of air intake to the stove. To decrease push knob to the left.

## AIRWASH SYSTEM

The air wash has an internal sliding plate with slots, housed in a cover plate, and is located above the fire door. Sliding the control knob to the right as far as it will go achieves the fully open position. Sliding it to the left will shut off the air inlet slots see page 17.



## OPERATING INSTRUCTIONS

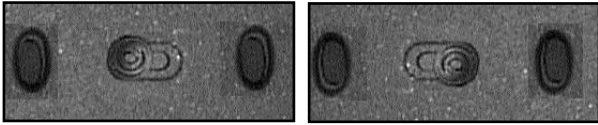

**Fig. 7 Fully Closed    Fig. 8 Fully Open**

Even when all the slots are completely shut a "bleed" of secondary air will be maintained ensuring that inflammable gases are burnt off.

### DISASSEMBLE AIRWASH

The Aarrow air wash may be disassembled for cleaning or adjustment. To achieve this, the following procedure should be followed:

- The door should be GENTLY lifted off its hinges so that the below operations can be carried out on a workbench or similar level surface.

This should be done when the appliance is cold.



**Fig. 9 Rear of the fire door**

- Remove the glass by unscrewing the top and bottom nuts.
- Carefully remove the glass and lift airwash cover off.
- Unscrew the airwash spring knob from the sliding plate.
- Remove assembly from the appliance.
- Clean and/or adjust.
- Refit using reverse procedure.

### MULTI - PURPOSE OPERATING TOOL

Your Aarrow stove comes with a multi-purpose tool, which is used for, riddling, setting the

multifuel grate position and for emptying the ash pan. (Fig. 10)



**Fig. 10**

### RIDDLING

Use the operating tool for setting the grate in the coal burning position or the wood burning position. This means that effective de-ashing (see page 19) takes place, and also allows the grate to be set in the coal burning or wood burning position, as indicated on the right hand side of the appliance.

### FIRE DOOR GLASS

In the event of the door glass being broken it can easily be replaced:

- The door should be GENTLY lifted off its hinges so that the below operations can be carried out on a workbench or similar level surface. This should be done when the appliance is cold.
- Unscrew the four nuts, on the inside of the door.
- Remove the upper airwash cover and the two lower glass clips.
- Carefully remove any pieces of broken glass, and sealing gasket wearing suitable gloves.

### REFIT NEW GASKET

- The fitting of new gasket is shown below (Fig.11a)



**Fig. 11a fitting new door gasket**

- Re-seat the new glass, ensuring the sealing gasket is flat and in contact with the glass (Fig.11b)

## OPERATING INSTRUCTIONS

---



**Fig. 11b fitting new glass**

- Replace the two lower retaining clips and nuts.
- Replace the upper airwash cover and nuts. Do not over-tighten the nuts as damage may occur to the glass (Fig.11c)



**Fig. 11c tightening nuts**

### ADJUSTING THE DOOR HINGES

Once the appliance has been under fire for a period of time the fire door may appear to have moved out of alignment with relation to the door aperture or catch. This is quite normal and due to the settling of the casing.

The fire door can be re-aligned by the user as follows:

- When the appliance is cold, open the fire door so that it is at right angles to the front of the fire.
- Lift the fire door up off its hinges.
- Gently tap the hinge pins in a direction to compensate for the misalignment (Fig. 12)

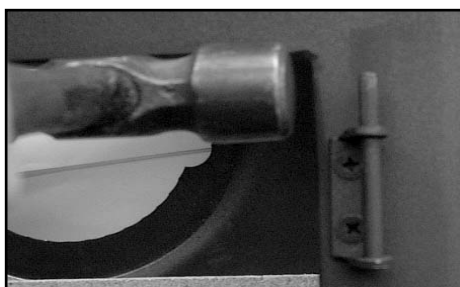

**Fig. 12 tapping door hinges**

- Refit the door and check to ensure it now sits square to the body; if not repeat above steps.

### FUEL TYPES

**Wood-** Any type of wood is suitable provided it is well seasoned and has a moisture content below 20%. This usually implies that the timber has been suitably stored to allow moisture to evaporate for at least nine months in the case of soft woods, and at least eighteen months in the case of hard wood. We recommend that for general burning, wood should be split into logs of no more than 130mm (5") diameter. Larger logs can be used for overnight burning.

**WARNING** wet wood must not be used as this will greatly contribute to the creation of tar and creosote which may, in extreme cases, run down the chimney in liquid form. This will seriously damage both the chimney and the appliance, and increase the risk of chimney fire.

*Note: If you have sticky tar inside the appliance or chimney your wood is 'Green' or too wet.*

#### **Recommended Reading:**

"Wood as Fuel" available from the Forestry Commission.

**Peat-** Can be used in turf or briquette form, but again the moisture content must be low.

**Paper-** paper will burn successfully. Burn dry paper only or chimney damage will occur.

**NEVER BURN PLASTICS OR WASTE IN YOUR STOVE.**

**Coal for Multifuel only** - Household coal produces a large amount of ash and smoke and chimney will require frequent cleaning. Therefore soft house coal is **not** recommended.

*Recommended fuels are as follows:*

*The Hetas Ltd, "Three tick" appliance approval only covers the use of the following fuels in this appliance; Phurnacite, Phurnacite Plus, Centurion, Maxibrite, Extracite, Pureheat, Blazebrite, Taybrite, Sunbrite (double/singles), Anthracite (large nuts), and Welsh Dry Steam Coal (large/small nuts).*

*Approval does not cover the use of other fuels either alone or mixed with a suitable fuel listed above, nor does it cover instructions for use of other fuels. For latest details please refer to Hetas website [www.hetas.co.uk](http://www.hetas.co.uk).*

**Do not use Homefire (six sided) and smaller sizes than Stovesse, e.g. Beans, Peas, Grains.**

**Do not use petroleum based solid products such as Calco or Petrocoke.**

**To do so will INVALIDATE the appliance guarantee.**

### LIGHTING THE FIRE

**Prior to lighting the fire for the first time check with the installer that:**

- Installation and all building work is complete.
- The chimney is sound and has been swept and is free from obstruction.
- Adequate provision for combustion air has been made, i.e. a permanent vent of at least 550mm<sup>2</sup> per kW of rated output above 5 kW, is fitted in the room in which the appliance is installed.
- That Building Regulations and any local by-laws have been followed during installation (see installation instructions).
- All firebox liner panels are in place.
- Throat plate is in place.
- That the chimney draw has been checked and is within specification. With the chimney warm the draught should be between 1 - 2mm water gauge (0.1 - 0.2mbar).

**WARNING:** An over drawing chimney can cause over-firing resulting in damage to the appliance.

**ENSURE THAT YOU HAVE READ & UNDERSTOOD THESE INSTRUCTIONS BEFORE LIGHTING THE FIRE.**

**ALWAYS WEAR SUITABLE PROTECTIVE FIRE GLOVES WHEN REFUELLING YOUR STOVE.**

### SOLID FUEL BURNING - Multifuel Stoves

- Ensure that the multifuel grate and ash pan are in

position and the fire doors are closed.

- Set the air wash to one quarter open position.
- Set the primary inlet to the fully open position
- Light in the normal manner with paper and kindling, or use a fire lighter.
- If using a gas poker be sure to remove it immediately the fire is alight.
- When the fire is well alight regulate the burning rate by adjusting the setting on the primary air inlet control.
- The air wash can be opened sufficiently to keep the door glass clean.

### BURNING WOOD

- Set air wash to the fully open position
- Proceed as for solid fuel but note the fire will burn up and become established more quickly.

### MIXED FUELS

- As per coal but allow additional secondary air.
- The primary air inlet can be closed and burning regulated by means of the air wash above the door.

### ANTHRACITE

Anthracite is more difficult to keep in for long periods, consequently more care in setting the controls and some familiarisation is necessary when burning anthracite.

Use the smallest size fuel (Stovesse or Small Nuts). Proceed as for manufactured smokeless fuel. Leave the air inlet control open about a quarter or less.

*Note: The high temperature paint acquires durability by being "cured" during the initial firings of the appliance will give off fumes which are non-toxic, but which certain persons may find have an unpleasant or irritant effect. Ensure that the area is well ventilated during this time.*

### EXTENDED BURNING

**The appliance will burn for an extended period provided:**

- Sufficient fuel is placed in the firebox.
- The controls are set correctly.
- Excess draught is not present in the chimney.
- Fire door is closed.
- If the fire goes out with unburnt fuel left in the firebox increase the air opening slightly, and vice versa.

## OPERATING INSTRUCTIONS

---

### In the morning

- Open the air control fully until embers begin to glow brightly and place pieces of fuel on the fire until it is well established.

**WARNING:** When wood is burnt slowly in a closed appliance it produces moisture and tar, which will create condensation and deposits in the chimney. This effect can be minimised by burning hard for a short period, about 20 minutes, twice a day. It is usually convenient to do this morning and night.

**Note:** *To avoid chimney problems your fire should not be burnt slowly for longer than 12 hours without a period of fast burning.*

**WARNING:** *Properly installed, with a suitable flue and chimney and operated and maintained this appliance will not emit fumes into the dwelling. Occasional fumes from the de-ashing and re-fuelling may occur. However, persistent fume emission is potentially dangerous and must be investigated by a Hetas registered installer. Stop using the appliance if you smell fumes or see smoke escaping.*

If fume emission does persist, the following immediate actions should be taken.

- Open doors and windows to ventilate room.
- Let the fire die or extinguish and safely dispose of fuel from the appliance.
- Check for flue or chimney blockage, and clean if required.

*Seek expert advice from your HETAS registered installer. Do not attempt to re-light the fire until the cause of the fume emission has been identified and corrected*

### ASH REMOVAL

The appliance will require ash to be removed periodically but an ash bed of approximately 20mm (3/4") should be maintained. Ash may be removed with a small shovel whilst the fire is still lit by raking the embers of a low fire to one side of the fire box and carefully removing the ash, then repeating the procedure for the other side. Care must be taken not to risk burning of hands or household objects from falling embers.

### DE - ASHING

It is necessary to maintain an ash layer on the upper surface of the grate bars, in order to protect them so de-ashing should cease as soon as the first red embers drop into the ash pan. Further de-ashing will cause heat build-up under the grate, which will considerably shorten its life. This operation should be carried out with the doors closed to prevent dust escaping into the room.

- Move up and down vigorously the riddling lever (ash will fall into the ash pan beneath the grate).
- When de-ashing is complete re-set grate to previous position.
- Empty ash pan.

**Note:** *Do not force the riddling mechanism.*

**TO EMPTY THE ASH PAN** Open the fire doors. Fit the fork end of the operating tool into the ash pan and remove from the ash pit chamber.

**WARNING:** The ash can be very hot. Empty only to a metal container. Even if the ash appears cold, red-hot pieces of ash may be concealed and could easily start a fire or cause an injury.

### CLINKER

The formation of clinker suggests that the unit is being over-fired. Any clinker forming on the grate should be removed when cold.

### OVER-FIRING

**Do not** over fire your appliance. Using flammable liquids or too much wood or firing the stove at maximum, for prolonged periods may result in over-firing. If the chimney connector or casing glows red the appliance is being over-fired. If this occurs immediately close all air inlets to the appliance to reduce the air supply to the fire. Should a chimney fire occur immediately close the appliance down. Get everyone out of the house and call the fire brigade. A chimney fire may cause structural damage to the chimney. Do not use the appliance until the chimney and connector have been inspected and any damaged parts have been repaired or replaced. This should be done by a competent person such as a HETAS registered engineer.

### CLEANING

Important; Under some circumstances soot can quickly build up on the throat plate and adjacent areas. The throat plate should be removed and checked monthly, and any debris stripped off. Similarly, clean the upper surface of the firebox.

### ANNUAL MAINTENANCE

*It is important that your fire is regularly serviced in accordance with these instructions. This should be carried out at least annually by a qualified person and should consist of the following.*

Remove the firebricks lining and throat plate, inspect all gasketing on doors, glass etc., and re-order any items that may need replacing, from your Aarrow dealer. With a wire brush clean inside the appliance paying attention to the small inlet holes on the fire door.

Sweep the chimney and confirm that it is sound. Examine all joints in the flue pipe etc., and re-seal if necessary. Reassemble and leave with the air inlet and air wash control about half way open. This will allow a free flow of air through the appliance thus preventing moisture and condensation from building up inside the fire and chimney.

### CHIMNEY SWEEPING

Sweeping should be carried out with an appropriate sized bristle brush and rods to suit chimney size and type. As with all appliances regular sweeping of the flue is essential to avoid the danger of blockage and the escape of poisonous fumes. Access for cleaning should also be incorporated in the chimney (e.g. soot door or access through register plate).

Any existing chimney should be swept prior to installation of the appliance, and swept again a second time **within one month** of regular use after installation to establish frequency of sweeping required.

This should be done by a competent person such as a NACS chimney engineer who will provide a Certificate of Chimney Sweeping.

The whole flue way including the outlet must be swept at least twice per burning season. It is important that the flue ways, flue pipe and chimney be cleaned prior to lighting the fire after a prolonged shut-down period.

### DOOR GLASS

The door glass should remain clear during normal daytime burning. However under certain conditions-such as burning at a low rate with damp wood, or overnight burning, the glass may become somewhat blackened. To remedy this, operate the appliance at a fast rate.

Alternatively when the stove is cold open the door and clean the inside face of the glass with a damp cloth or with glass cleaner (available from fire stockists). A piece of cloth moistened with vinegar and dipped in wood ash - **not coal ash** - will provide a good soft scourer to remove the soot without scratching the glass.

### OUTER FINISH

The outside finish of the appliance is a durable high temperature paint. It is best cleaned by brushing down with a clean shoe brush. Do not allow moisture to remain on the appliance whilst cold or surface rust may form.

The high temperature paint should not require attention for some time, depending on use. The hotter the fire burns the sooner repainting will be necessary. Aerosol tins of paint are available for complete refurbishing. Before repainting make sure that the fire is out and is cold.

- Remove the door glass.
- Lightly wire brush, or rub with wire wool, the body of the appliance to remove any loose paint powder.
- Mask or remove items such as brass work.
- Any adjacent brickwork, mantelpiece, hearth, etc., should be carefully masked for quite a distance around the appliance. (this precaution is to prevent discolouration of the surrounding brickwork, wallpaper etc).

**Re-spray in a well-ventilated area - avoid breathing the vapour. Refer to safety instructions on paint cans.**

- When the paint is dry refit door glass and any other parts previously removed.
- Leave the appliance for eight hours before-lighting.
- Burn slowly for the first four hours, then build up heat gradually to cure the paint.

*Note: Use only genuine Aarrow touch-up spray as some paints interact. This could ruin the finish and invalidate the guarantee.*

*Note: Cracking of lining panels does not effect efficiency.*

# FINAL CHECK LIST







## CHECKLIST

### Hearths, Fireplaces, Flues and chimneys







This checklist is to ensure hearths, fireplaces, flues and chimneys are satisfactory, and to show what you have done to comply with the requirements of The Building Regulations 2000 Approved Document J 2002.

1. Building address, where work has been carried out..... .....	
2. Identification of hearth, fireplace chimney or flue	
3. Firing capability: solid fuel/gas/.	
4. Intended type of appliance. State model and output.	
5. Ventilation provisions for the appliance: State type and area of permanently open vents.	
6. Chimney or flue construction a) State the type or make and whether new or existing. b) internal flue size (and equivalent height, where calculated - natural draught gas appliances only). c) If clay or concrete flue liners used confirm that they are correctly jointed with socket end uppermost and state jointing materials used. d) If an existing chimney has been refurbished with a new liner, type or make of liner fitted. e) Details of flue outlet terminal and diagram reference. Outlet Details:  Complies with:  f) Number and angle of bends. g) Provision for cleaning and recommended frequency.	
7. Hearth. Form of construction. New or existing?	
8. Inspection and testing after completion Tests carried out by: Tests and results Flue inspection visual sweeping coring ball smoke Appliance (where included) spillage	
<p>I/we the undersigned confirm that the above details are correct. In my opinion, these works comply with the relevant requirements in Part J of Schedule 1 to the Building regulations.</p> <p>Print name and title.....Profession.....</p> <p>Capacity.....Telephone.....</p> <p>Address.....Post code.....</p> <p>Signed.....Date.....</p> <p>Registered membership of...(e.g. CORGI, OFTEC, HETAS, NACE, NACS).....</p>	

## PARTS LIST







Part Description	Visual Aid (not to scale)	Acorn 4 Part No.	Acorn 5 Part No.
1. Integral Front Brace/ Retainer		AFS1101	AFS1101
2. Throat Plate		AFS1086	AFS1018
3. Grate Bar		AFS001	AFS001
4. Hot Plate		AFS064	AFS064
5. Operating Tool		AFS008	AFS008
6. Ashpan		AFS1141	AFS1141
7. Flue Spigot		AFS009A	AFS009A

## PARTS LIST

Part Description	Visual Aid (not to scale)	Acorn 4 Part No.	Acorn 5 Part No.
8. Liner Set		AFS1090	AFS1015
9. Side Liner		AFS1092	AFS1058
10. Back Liner Set		AFS1094	AFS1059
11. Glass Replacement Kit Complete with Gasket		AFS1095	AFS1095
12. Glass Clips		AFS1096	AFS1096
13. Hinge kit Comprises 2 Hinges & 4 Fixings Per Set.		AFS047	AFS047
14. Airwash		AFS1097	AFS1097



## PARTS LIST

Part Description	Visual Aid (not to scale)	Acorn 4 Part No.	Acorn 5 Part No.
15. Fire Door Rope Kit Complete with Door Rope Glue.		AFS048	AFS048
16. Main Door Assembly Complete with Handle, Glass, Gaskets, Clips and Seal.		AFS1099	AFS1099
17. Comb with Extension		AFS1100	AFS1149
18. Fire Door Locking Assembly Including Fire Door Handle		AFS204	AFS204
19. Rear Grate Bar Support		AFS1117	AFS1117
20. Arrow Fires Gauntlet Gloves		AFS997	AFS997
21. Optional Floor Fixing Kit.		AFS1135	AFS1135

## GUARANTEE

---

### *Guarantee*

Once again we would like to thank you for buying an Arrow fire.

When you buy an **Arrow Fire**, you are not only buying a first class appliance - you are buying a commitment from us to look after you and your appliance for as long as you want.

Your Arrow Fire carries a guarantee against defects of manufacture and faulty workmanship for a period of three years from the date of purchase. This does not apply to items which would be subject to fair wear or tear. Firebox liner panels, fuel retainers, throat plate, door rope, door glass and gaskets are not covered by the guarantee. However, should you have any problems with your appliance please contact your Arrow stockist who will have the knowledge and facilities to help you.

Arrow Fires Ltd will not be responsible for any consequential or incidental loss, damage, or injury however caused.

**Claims are not valid where the installation does not conform to local Building Regulations and fire codes.**

The Guarantee is conditional upon the appliance being serviced and checked annually by a qualified heating engineer.

The Manufacturers decision shall be final.

**If your appliance proves to be defective as a result of faulty materials or workmanship during guarantee, we will repair or replace it FREE OF CHARGE as long as the fire has been installed according to the manuals instructions.**

**USE OF SPARE PARTS OTHER THAN THOSE SUPPLIED BY AARROW FIRES LTD WILL INVALIDATE THE APPLIANCE WARRANTY.**

All Guarantee periods commence on the date of purchase and are non-transferable.

Our Guarantee is offered as an addition to your statutory rights.

If you think your fire is not working correctly or in the case of a breakdown, **please call your local Arrow Fires retailer**, who will have the knowledge and experience to assist you.

When you contact them they will need to know :

1. Your name, address, post code and telephone number.
2. Stove serial number
3. Clear and concise details of the fault.

---

### CUSTOMER REGISTRATION

See card enclosed

**To guarantee the very best in after-sales service, do not forget to complete and return your Customer Registration Card within 14 days (a stamp is required).**

Just complete the form and return it to us to benefit from our *three year Guarantee*.

**Please contact us direct 01308 427234 if no Customer Registration Card is included.**



**FINAL FACTORY CHECK LIST**

Model.....
Serial No.....

QUALITY	
FINISH	
PARTS	
FLUE OUTLET	
HOT PLATE	
FRONT INTEGRAL BRACE	
GRATE	
FIREBOX LININGS	
THROAT PLATE	
AIR WASH	
DOOR CATCHES	
ASH PAN	
OPERATING TOOL	
OPERATING INSTRUCTIONS	

***I've checked it  
and it's O.K.***

Assembled by.....

Checked by .....

Please ensure the enclosed registration card is completed and returned to Aarrow Fires and the following information completed for your own information.

Date of Purchase.....

Name and address of supplier.....

.....

.....

*\* Please ensure installer completes **INSTALLATION CHECK LIST** details on page 22 of this manual.*